

U.S. ENVIRONMENTAL PROTECTION AGENCY
UNDERGROUND INJECTION CONTROL PERMIT CLASS VI

TABLE OF CONTENTS

PERMIT CONDITIONS2

A. EFFECT OF PERMIT.....2

B. PERMIT ACTIONS2

C. SEVERABILITY2

D. CONFIDENTIALITY3

E. DEFINITIONS3

F. DUTIES AND REQUIREMENTS3

G. AREA OF REVIEW AND CORRECTIVE ACTION.....5

H. FINANCIAL RESPONSIBILITY5

I. WELL CONSTRUCTION7

J. PRE-INJECTION TESTING8

K. INJECTION WELL OPERATING REQUIREMENTS.....10

L. MECHANICAL INTEGRITY12

M. SEISMIC EVENT RESPONSE15

N. TESTING AND MONITORING REQUIREMENTS.....16

O. REPORTING AND RECORDKEEPING.....19

P. WELL PLUGGING, POST-INJECTION SITE CARE, AND SITE CLOSURE23

Q. EMERGENCY AND REMEDIAL RESPONSE26

R. COMMENCING INJECTION.....27

ATTACHMENTS28

LIST OF ATTACHMENTS

- A. SUMMARY OF REQUIREMENTS
- B. AREA OF REVIEW AND CORRECTIVE ACTION PLAN
- C. TESTING AND MONITORING PLAN
- D. WELL PLUGGING PLANS
- E. POST-INJECTION SITE CARE AND SITE CLOSURE PLAN
- F. EMERGENCY AND REMEDIAL RESPONSE PLAN
- G. CONSTRUCTION DETAILS
- H. PRE-INJECTION TESTING PLAN
- I. FINANCIAL ASSURANCE DEMONSTRATION
- J. STIMULATION PROGRAM



REGION 5

CHICAGO, IL 60604

Page 1 of 28

**UNITED STATES ENVIRONMENTAL PROTECTION AGENCY
UNDERGROUND INJECTION CONTROL PERMIT: CLASS VI**

Permit Number: IN-165-6A-0001

Facility Name: WVCCS#1

Pursuant to the Safe Drinking Water Act and Underground Injection Control regulations codified at Title 40 of the Code of Federal Regulations (40 C.F.R) Parts 124, 144, 146, and 147,

Wabash Carbon Services, LLC, of West Terre Haute, Indiana

hereinafter, the permittee, is hereby authorized to construct and operate a Class VI injection well located in the State of Indiana, Vermillion County, T14N, R10W of 3rd Principal Meridian, Section 26, 39°37'27.88"N, -87°29'19.17"W, for injection of the carbon dioxide stream generated by Wabash Carbon Services, LLC production facility and as characterized in the permit application and the administrative record as a liquid, supercritical fluid, or gas into the Oneota and Potosi Formations at depths between 3,970 feet and 5,162 feet below ground surface upon the express condition that the permittee meet the restrictions set forth herein. Injection must not commence until the operator has received written authorization from the Director of the Water Division of the U.S. Environmental Protection Agency (EPA) Region 5.

All references to Title 40 of the Code of Federal Regulations are to all regulations that are in effect on the date that this permit is effective. The following attachments are incorporated into this permit as enforceable conditions: A, B, C, D, E, F, G, H, I, and J.

This permit becomes effective on **March 9, 2024**, and remains in full force and effect during the operating life of the injection well, the post-injection site care period, and until site closure is authorized and completed, unless this permit is revoked and reissued, terminated, or modified pursuant to 40 C.F.R. §§ 144.39, 144.40, or 144.41. Upon delegation of primary enforcement responsibility to the State of Indiana, this permit also remains in effect until such time as the State issues its own permit to the permittee or the State chooses to adopt this permit as the State permit. The permit will expire in two years from its effective date if the permittee fails to commence well construction, unless a written request in an electronic format for an extension of this two-year period has been approved by the Director. Requests for extension must state delay causality, an estimated well completion date, and list additional wells that penetrate the designated confining zone within the area of review (AOR) which were not included in the initial permit application, including well construction diagrams, cement records, and cement bond logs for any new AOR wells. A maximum of two, two-year extensions are allowed. If the construction of the well has not commenced during the maximum period of six years from the effective date, the permit expires and may not be extended. The permittee may request an expiration date sooner than the two-year period, provided no construction on the well has commenced.

Signed and dated:

1/19/2024

X

Tera L. Fong
Director, Water Division
Signed by: TERA FONG

PERMIT CONDITIONS

A. EFFECT OF PERMIT

The permittee is allowed to engage in underground injection in accordance with the conditions of this permit. Notwithstanding any other provisions of this permit, the permittee authorized by this permit must not construct, operate, maintain, convert, plug, abandon, or conduct any other injection activity in a manner that allows the movement of injection, annulus, or formation fluids into underground sources of drinking water (USDWs) or any unauthorized geologic zones. The objective of this permit is to prevent the movement of fluids into or between USDWs or into any unauthorized geologic zones consistent with the requirements at 40 C.F.R. §§ 146.86(a) and 144.12(a) and (b). Any underground injection activity not specifically authorized in this permit is prohibited. For purposes of enforcement, compliance with this permit during its term constitutes compliance with Part C of the Safe Drinking Water Act (SDWA). Such compliance does not constitute a defense to any action brought under Section 1431 of the SDWA or any other common or statutory law other than Part C of the SDWA. Issuance of this permit does not convey property rights of any sort or any exclusive privilege; nor does it authorize any injury to persons or property, any invasion of other private rights, or any infringement of State or local laws or regulations. Nothing in this permit shall be construed to relieve the permittee of any duties under applicable regulations.

B. PERMIT ACTIONS

1. **Modification, Revocation and Reissuance, and Termination** – The Director of the Water Division of Region 5 of the EPA, hereinafter, the Director, may, for cause or upon request from any interested person, including the permittee, modify, revoke and reissue, or terminate this permit in accordance with 40 C.F.R. §§ 124.5, 144.12, 146.86(a), 144.39, and 144.40. The permit is also subject to minor modifications for cause as specified in 40 C.F.R. § 144.41. The filing of a request for a permit modification, revocation and reissuance, or termination, or the notification of planned changes, or anticipated noncompliance on the part of the permittee does not stay the applicability or enforceability of any permit condition.
2. **Minor Modifications** – Upon the consent of the permittee, the Director may modify a permit to make the corrections or allowances for minor changes in the permitted activity as listed in 40 C.F.R. § 144.41. Any permit modification not processed as a minor modification under 40 C.F.R. § 144.41 must be made for cause, and with part 124 draft permit and public notice as required in 40 C.F.R. § 144.39.
3. **Transfer of Permits** – This permit is not transferable to any person except in accordance with 40 C.F.R. § 144.38(a) and Section O(7)(b) of this permit.

C. SEVERABILITY

The provisions of this permit are severable, and if any provision of this permit or the application of any provision of this permit to any circumstance is held invalid, the application of such provision to other circumstances and the remainder of this permit shall not be affected thereby.

D. CONFIDENTIALITY

In accordance with 40 C.F.R. Part 2 (Public Information) and 40 C.F.R. § 144.5, any information submitted to EPA pursuant to this permit may be claimed as confidential business information by the submitter. Any such claim must be asserted at the time of submission by clearly identifying each page with the words "confidential business information" on every page containing such information. If no claim is made at the time of submission, EPA may make the information available to the public without further notice. If a claim is asserted, the validity of the claim will be assessed in accordance with the procedures in 40 C.F.R. Part 2. Claims of confidentiality for the following information will be denied:

1. The name and address of the permittee; and
2. Information which deals with the existence, absence, or level of contaminants in drinking water.

E. DEFINITIONS

All terms used in this permit shall have the meaning set forth in the SDWA and Underground Injection Control regulations specified at 40 C.F.R. parts 124, 144, 146, and 147. Unless specifically stated otherwise, all references to "days" in this permit should be interpreted as calendar days.

F. DUTIES AND REQUIREMENTS

1. **Prohibition of Movement of Fluid into a USDW** – The Permittee must not construct, operate, maintain, convert, plug, abandon, or conduct any other injection activity in a manner that allows the movement of a fluid containing any contaminant into USDWs. If any water quality monitoring of a USDW indicates the movement of any contaminant into the USDW, the Director may take enforcement action or prescribe such additional requirements for construction, corrective action, operation, monitoring, or reporting (including closure of the injection well) as are necessary to remediate and prevent such movement.
2. **Duty to Comply** – The permittee must comply with all conditions of this permit. Any permit noncompliance constitutes a violation of the SDWA and is grounds for enforcement action, permit termination, revocation and reissuance, modification, or for denial of a permit renewal application.
3. **Duty to Reapply** – If the permittee wishes to continue an activity regulated by this permit after its expiration, the permittee must apply for and obtain a new permit.
4. **Penalties for Violations of Permit Conditions** – Any person who violates a permit requirement is subject to civil and/or criminal penalties and other enforcement action under the SDWA. Any person who willfully violates permit conditions may be subject

to criminal prosecution under the SDWA and other applicable statutes and regulations.

5. **Need to Halt or Reduce Activity Not a Defense** – It shall not be a defense for the permittee in an enforcement action to claim that it would have been necessary to halt or reduce the permitted activity in order to maintain compliance with the conditions of this permit.
6. **Duty to Mitigate** – The permittee must take all timely and reasonable steps necessary to minimize or correct any adverse impact on the environment resulting from noncompliance with this permit.
7. **Proper Operation and Maintenance** – The permittee must at all times properly operate and maintain all facilities and systems of treatment and control and related appurtenances which are installed or used by the permittee to achieve compliance with the conditions of this permit. Proper operation and maintenance includes, among other things, effective performance, adequate funding, adequate operator staffing and training, and adequate laboratory and process controls, including appropriate quality assurance procedures. This provision requires the operation of back-up or auxiliary facilities or similar systems only when necessary to achieve compliance with the conditions of this permit.
8. **Duty to Provide Information** – The permittee must furnish to the Director in electronic format, within the time specified by the type of submittal or as defined by the Director, any information which the Director may request to determine whether cause exists for modifying, revoking and reissuing, or terminating this permit, or to determine compliance with this permit or the UIC regulations. The permittee must also furnish to the Director, upon request within a time specified, electronic copies of records required to be kept by this permit. The permittee must also comply with all reporting requirements of this permit, and as required by 40 C.F.R. § 144.32.
9. **Inspection and Entry** – The permittee must allow the Director or an authorized representative, upon the presentation of credentials and other documents as may be required by law, to:
 - (a) Enter upon the permittee's premises where a regulated facility or activity is located or conducted, or where electronic or non-electronic records are kept under the conditions of this permit;
 - (b) Have access to and copy, at reasonable times, any electronic or non-electronic records that are kept under the conditions of this permit;
 - (c) Inspect, at reasonable times, any facilities, equipment (including monitoring and control equipment), practices, or operations regulated or required under this permit; and
 - (d) Sample or monitor, at reasonable times, for the purposes of assuring permit compliance or as otherwise authorized by the SDWA, any substances or parameters

at any location, including facilities, equipment or operations regulated or required under this permit.

10. **Signatory and Certification Requirements** – All reports, notifications, or any other information, required to be submitted by this permit or requested by the Director must be signed and certified in accordance with 40 C.F.R. § 144.32.

G. AREA OF REVIEW AND CORRECTIVE ACTION

The Area of Review (AoR) is the area surrounding the injection well where USDWs may be endangered by the injection activity. The area of review was delineated using computational modeling that accounts for the physical and chemical properties of all phases of the injected carbon dioxide stream and is based on available site characterization, monitoring, and operational data. The permittee must maintain and comply with the approved AoR and Corrective Action Plan (CAP) included as Attachment B, which is an enforceable condition of this permit, and must meet the requirements of 40 C.F.R. § 146.84.

1. Every 5 years as specified in the AoR and CAP, or more frequently when monitoring and operational conditions warrant, the permittee must reevaluate the area of review and perform corrective action in the manner specified in 40 C.F.R. § 146.84 and update the AoR and CAP or demonstrate to the Director that no update is needed. Reevaluation of the AoR and CAP must meet the requirements of § 146.84(e) and must include a new survey of wells within the existing or modified AoR; and
2. Following each AoR reevaluation or a demonstration that no evaluation is needed, the permittee must submit a report of the resultant information in an electronic format to the Director for review and approval. Once approved by the Director, the revised AoR and CAP will become an enforceable condition of this permit.

H. FINANCIAL RESPONSIBILITY

The permittee must maintain financial responsibility that meets the requirements of 40 C.F.R. § 146.85 for the life of this permit until site closure is approved by the Director. The permittee must use financial instruments as listed in 40 C.F.R. § 146.85(a)(1) to cover all costs associated with the requirements of this permit. The approved financial responsibility and estimated costs for this permit are found in Attachment I and in the administrative record of this permit.

1. **Costs to be Covered** – The financial instrument(s) must be sufficient to cover the cost of:
 - (a) Corrective action (that meets the requirements of 40 C.F.R. § 146.84);
 - (b) Injection well plugging (that meets the requirements of 40 C.F.R. § 146.92);
 - (c) Post injection site care and site closure (that meets the requirements of 40 C.F.R. § 146.93);

- (d) Emergency and remedial response (that meets the requirements of 40 C.F.R. § 146.94).
2. **Cost Estimate Updates and Adjustments** – A detailed written estimate for each phase listed in Section H(1) of this permit. Cost estimates must be prepared by a third party that is independent from the corporate structure of the permittee and must be approved by the Director per § 146.85(c). During the life of this permit, the permittee must adjust the cost estimate for annual inflation and any amendments made to the Project Plans included as Attachments B-G of this permit, which address costs associated with items (a) through (d) in Section H(1) of this permit. Cost estimates must be adjusted annually within 60 days prior to the anniversary date of the establishment of the financial instrument(s) and provide this adjustment to the Director in an electronic format. All cost and Project Plan adjustments are subject to the Director's approval.
3. **Notification** –
- (a) Whenever a cost estimate increases to an amount greater than the face amount of a controlling financial instrument, the permittee, within 60 days after the increase, must either cause the face amount to be increased to an amount at least equal to the current cost estimate and submit evidence of such increase to the Director, or obtain other financial responsibility instruments to cover the increase. Whenever a current cost estimate decreases to an amount less than the face amount of a controlling financial instrument, the face amount of the financial assurance instrument may be reduced to the amount of the current cost estimate only after the permittee has received written approval from the Director.
- (b) The permittee must notify the Director by certified mail and in an electronic format of adverse financial conditions, such as bankruptcy, that may affect the ability to carry out injection well plugging, post-injection site care and site closure, and any applicable ongoing actions under Corrective Action and/or Emergency and Remedial Response.
- (i) In the event that the permittee or the third-party provider of a financial responsibility instrument is going through a bankruptcy, the permittee must notify the Director by certified mail and in an electronic format of the commencement of a voluntary or involuntary proceeding under Title 11 (Bankruptcy), U.S. Code, naming the permittee as debtor, within 10 days after commencement of the proceeding.
- (ii) A guarantor of a corporate guarantee must make such a notification if he or she is named as debtor, as required under the terms of the guarantee.
- (iii) A permittee who fulfills the requirements Section H and Attachment I of this section by obtaining a trust fund, surety bond, letter of credit, escrow account, or insurance policy will be deemed to be without the required financial assurance in the event of bankruptcy of the trustee or issuing institution, or a

suspension or revocation of the authority of the trustee institution to act as trustee of the institution issuing the trust fund, surety bond, letter of credit, escrow account, or insurance policy.

4. **Establishing Other Coverage** – The permittee must establish other financial assurance or liability coverage acceptable to the Director, within 60 days of the occurrence of the events in Section H(2), H(3), or H(4) of this permit.

I. WELL CONSTRUCTION

The design and specifications for the injection well, injection zone monitoring wells, confining zone monitoring wells, and the groundwater monitoring wells are included in Attachment G of this permit.

1. **Injection Well Construction** – The well must be constructed in accordance with 40 C.F.R § 146.86. The design and construction must allow continuous monitoring of the annulus between the long string casing and the injection tubing and accommodate testing devices and workover tools. During construction, the Permittee may make changes to the design of the injection well consistent with the conditions of this permit. If changes are made to the design of the well, notification must be made to EPA and the construction changes must be provided for review and approval by the Director before installation. Once the construction of the well is completed, and prior to authorization to inject, the permittee must submit the final, as-built construction specifications and diagrams within 30 days for review and approval by the Director. Any deviations from the proposed design and as-built construction of the well must be noted. If the changes in well design are significant, the Director may require this permit to be modified.
2. **Siting** – The permittee has demonstrated to the satisfaction of the Director that the well is in an area with suitable geology in accordance with the requirements at 40 C.F.R. § 146.83.
3. **Casing and Cementing** – The well must be cased and cemented per 40 C.F.R. §§ 146.22 and 146.86. Casing, cement, or other materials used in the construction of the well must have sufficient structural strength for the life of the geologic sequestration project. All well materials must be compatible with all fluids with which the materials may be expected to come into contact and must meet or exceed standards developed for such materials by the American Petroleum Institute, ASTM International, or comparable standards acceptable to the Director. The casing and cementing program must prevent the movement of fluids into or between USDWs for the expected life of the well in accordance with 40 C.F.R. §146.86. Because the injection well is located in an area where un-reclaimed, abandoned subsurface coal mines may exist, well construction must include an additional mining casing outside of the surface casing to seal the mine void space from the inner casings of the well. The mining casing shoe must be set at least 50 feet below the bottom of the mine void space and the surface casing shoe must be set at sufficient depth so that the mine void space and the

overlying geologic units are sufficiently sealed. The casing and cement used in the construction of this well are shown in Attachment G of this permit and in the administrative record for this permit. Any changes must be submitted in an electronic format for approval by the Director before installation.

4. **Tubing and Packer Specifications** – The tubing and packer design must meet the requirements of 40 C.F.R. § 146.86(c). Tubing and packer materials used in the construction of the well must be compatible with fluids with which the materials may be expected to come into contact and must meet or exceed standards developed for such materials by the American Petroleum Institute, ASTM International, or comparable standards acceptable to the Director. Injection must only take place through the tubing, with a packer set in the long string casing within or below the nearest cemented and impermeable confining system no more than 100 feet above the injection zone. The tubing and packer used in the well are represented in engineering drawings contained in Attachment G of this permit. Any change must be submitted in an electronic format for review and approval by the Director before installation.
5. **Sampling and Monitoring Devices** – The permittee must install and maintain in good condition all devices required to measure, monitor, and record the data required by Attachment C of this permit. The Permittee must ensure that the devices installed and methods used are sufficient to represent the activity being measured, monitored, or recorded. Calculated flow data or periodic monitoring are not acceptable for required continuous monitoring except as a back-up system if the primary continuous monitoring devices become inoperable. EPA must be notified of such occurrences, and continuous monitoring devices should be repaired or replaced as soon as practicable. If this period of time is extensive in the opinion of the Director, injection activities must cease until such time that normal monitoring is restored. The Permittee must ensure the well's construction and near-wellhead design is appropriate for the collecting of samples and fulfilling of all monitoring requirements of this permit. The permittee must ensure all gauges used for monitoring and testing are properly calibrated.
6. **Monitoring Well Construction**– 40 C.F.R. §§ 146.84 and 146.90(g) require monitoring of the carbon dioxide plume and pressure front of the confining and injection zones and 40 C.F.R. § 146.90(d) requires monitoring of groundwater located above the injection zone. These sections are incorporated by reference into this permit. Groundwater, confining zone, and injection zone monitoring wells must be constructed in the manner depicted in Attachment G of this permit using materials that are compatible with the injected fluids. All monitoring wells must be constructed in a manner to provide representative samples that can be analyzed for the monitoring parameters required by this permit. Once the construction of the monitoring wells has been completed, the as-built construction diagrams must be included in the Pre-injection Testing Report to be submitted to the Director per Section J of this permit.

J. PRE-INJECTION TESTING

Testing is required during the construction of the well per 40 C.F.R. § 146.87. This

testing is required to verify the geology of the well site to ensure compliance with the well construction requirements per 40 C.F.R. § 146.86 and to test viability of the well to meet the stipulated operational requirements. All testing must be conducted in accordance with 40 C.F.R. § 146.87. The pre-injection testing plan is included as Attachment H of this permit.

1. Prior to the Director authorizing injection, the permittee must perform all pre-injection logging, sampling, and testing specified at 40 C.F.R. § 146.87. This testing must include:
 - (a) Logs, surveys and tests to determine or verify the depth, thickness, porosity, permeability, lithology, and formation fluid salinity in all relevant geologic formations. These tests must include:
 - (i) Deviation checks that meet the requirements of 40 C.F.R. § 146.87(a)(1);
 - (ii) Logs and tests before and upon installation of the surface casing that meet the requirements of 40 C.F.R. § 146.87(a)(2);
 - (iii) Logs and tests before and upon installation of the long-string casing that meet the requirements of 40 C.F.R. § 146.87(a)(3);
 - (iv) Tests to demonstrate internal and external mechanical integrity that meet the requirements of 40 C.F.R. § 146.87(a)(4); and
 - (v) Any alternative methods that are required by and/or approved by the Director pursuant to 40 C.F.R. § 146.87(a)(5).
 - (b) Whole cores or sidewall cores of the injection zone and confining system and formation fluid samples from the injection zone that meet the requirements of 40 C.F.R. § 146.87(b).
 - (c) Documentation of the measured fluid temperature, pH, conductivity, reservoir pressure, and static fluid level of the injection zone that meet the requirements of 40 C.F.R. § 146.87(c).
 - (d) Tests to determine well-specific data regarding the injection and confining zones. These tests must determine fracture pressure and the physical and chemical characteristics of the injection and confining zones and the formation fluids in the injection zone that meet the requirements of 40 C.F.R. § 146.87(d).
 - (e) Tests to verify hydrogeologic characteristics of the injection zone that meet the requirements of 40 C.F.R. § 146.87(e), including:
 - (i) A pressure fall-off test; and

- (ii) A pumping test or injectivity tests.
2. The permittee must submit to the Director for approval in an electronic format a schedule for pre-operational testing activities 30 days prior to conducting the first test and submit any changes to the schedule 30 days prior to the next scheduled test. The permittee must provide the Director with the opportunity to witness all logging, sampling, and testing required under this Section.

K. INJECTION WELL OPERATING REQUIREMENTS

1. **Injection Pressure Limitation** – Except during stimulation, the permittee must ensure that injection pressure does not exceed 90 percent of the fracture pressure of the injection zone(s) to ensure that the injection does not initiate new fractures or propagate existing fractures in the injection zone(s). Under no circumstance shall injection pressure initiate fractures or propagate existing fractures in the confining zone or cause the movement of injection or formation fluids into a USDW. The maximum injection pressure limit is listed in Attachment A of this permit.
2. **Stimulation Program** – All stimulation activities must be approved by the Director prior to conducting the stimulation. The permittee must carry out the Stimulation Program in accordance with Attachment J of this permit.
3. **Additional Injection Limitations** – No injection fluid other than that identified on Page 1 of this permit may be injected except fluids used for stimulation, rework, and well tests as approved by the Director. Injection must occur within the injection tubing.
4. **Annulus Fluid** – The permittee must fill the annulus between the tubing and the long string casing with a non-corrosive fluid approved by the Director.
5. **Annulus/Tubing Pressure Differential** – Except during workovers or times of annulus maintenance, the permittee must maintain pressure on the annulus that exceeds the operating injection pressure as specified in Attachment A of this permit, unless the Director determines that such requirement might harm the integrity of the well or endanger USDWs.
6. **Automatic Alarms and Automatic Shut-off System** –
 - (a) The permittee must:
 - (i) Install, continuously operate, and maintain an automatic alarm and automatic shut-off system or, at the discretion of the Director, down-hole shut-off systems, or other mechanical devices that provide equivalent protection; and
 - (ii) Successfully demonstrate the functionality of the alarm system and shut-

off system prior to the Director authorizing injection, and at a minimum of once every twelfth month after the last approved demonstration.

- (b) Testing under this Section must involve subjecting the system to simulated failure conditions and must be witnessed by the Director or his or her representative unless the Director authorizes an unwitnessed test in advance. The permittee must provide notice in an electronic format 30 days prior to running the test and must provide the Director or their representative the opportunity to attend. The test must be documented using either a mechanical or digital device which records the value of the parameter of interest, or by a service company job record. A final report including any additional interpretation necessary for evaluation of the testing must be submitted in an electronic format within the time period specified in Section O(4) of this permit.

7. **Precautions to Prevent Well Blowouts** – Except at specific times as approved by the Director, the permittee must maintain on the well a pressure which will prevent the return of the injection fluid to the surface. The well bore must be filled with a fluid of sufficient specific gravity during workovers to maintain a positive (downward) pressure gradient and/or a plug shall be installed which can resist the pressure differential. A blowout preventer must be installed and kept in proper operational condition whenever the wellhead is removed to work on the well. The permittee must follow procedures such as those below to assure that a backflow or blowout does not occur:

- (a) Limit the temperature and/or corrosivity of the injectate; and
- (b) Develop procedures necessary to assure that pressure imbalances do not occur.

8. **Circumstances Under Which Injection Must Cease** –

Injection must cease when any of the following circumstances arises:

- (a) Failure of the well to pass a mechanical integrity test;
- (b) A loss of mechanical integrity during operation;
- (c) The automatic alarm or automatic shut-off system is triggered;
- (d) A significant unexpected change in the annulus or injection pressure;
- (e) The Director determines that the well lacks mechanical integrity; or
- (f) The Director determines that the permittee is unable to maintain compliance with any condition of this permit or regulatory requirement and the Director determines that injection should cease.

L. MECHANICAL INTEGRITY

The injection well must maintain internal (casing, tubing and packer) and external (fluid movement into geologic units other than the injection zone) mechanical integrity for the entirety of its operational life. No significant leaks in the casing, tubing, or packer can occur without corrective actions. The determination of whether the injection well has mechanical integrity is at the discretion of the Director. Mechanical integrity is determined through testing and test procedures approved by the Director. Approved mechanical integrity testing procedures are in the Testing and Monitoring Plan in Attachment C of this permit. Other tests and/or procedures not listed in this plan will be considered by the Director for approval.

1. **Standards** – Other than during periods of well workover (repair or maintenance) approved by the Director in which the sealed tubing-casing annulus is disassembled for maintenance or corrective procedures, the injection well must have and maintain mechanical integrity consistent with 40 C.F.R. § 146.89. To meet these requirements, mechanical integrity tests/demonstrations must be witnessed by the Director or an authorized representative of the Director unless prior approval has been granted by the Director to run an un-witnessed test. In order to conduct testing without an EPA representative, the following procedures must be followed.
 - (a) The permittee must submit prior notification in an electronic format within the time period specified in Section L(3) of this permit, including the information that no EPA representative is available, and receive permission from the Director to proceed;
 - (b) The test must be performed in accordance with the Testing and Monitoring Plan (Attachment C of this permit) and documented using either a mechanical or digital device that records the value of the parameter of interest; and
 - (c) A final report including any additional interpretation necessary for evaluation of the testing must be submitted in an electronic format within the time period specified in Section O(4) of this permit.
2. **Mechanical Integrity Testing** – The permittee must conduct a casing inspection log and mechanical integrity testing (MIT) as follows:
 - (a) After construction, and prior to receiving authorization to inject from the Director, the permittee must demonstrate internal mechanical integrity of the well. This demonstration is achieved by the performance of the following testing pursuant to 40 C.F.R. § 146.87(a)(4):
 - (i) A pressure test with liquid or gas; and
 - (ii) A casing inspection log; or

- (iii) An alternative approved by the Director that has been approved by the Administrator pursuant to requirements at 40 C.F.R. § 146.89(e).
 - (b) Prior to receiving authorization to inject, the permittee must perform the following testing to demonstrate external mechanical integrity pursuant to 40 C.F.R. § 146.87(a)(4):
 - (i) Tracer surveys such as an oxygen activation log; or
 - (ii) Temperature or noise logs; or
 - (iii) An alternative approved by the Director that has been approved by the Administrator pursuant to requirements at 40 C.F.R. § 146.89(e).
 - (c) Other than during periods of well workover (repair or maintenance) approved by the Director, in which the sealed tubing-casing annulus is disassembled for maintenance or corrective procedures, the permittee must continuously monitor injection pressure, injection rate, injection mass, pressure on the annulus between tubing and long string casing, and annulus fluid volume as specified in 40 C.F.R. §§ 146.88(e) and 146.89(b).
 - (d) At least once per year, the permittee must perform the testing to demonstrate external mechanical integrity pursuant to 40 C.F.R. § 146.89(c) and as listed in Section L(2)(b) of this permit.
 - (e) After any well repair or workover that may compromise the internal mechanical integrity of the well, the internal mechanical integrity of the well must be demonstrated by conducting test(s) approved by the Director. For injection to recommence, the well must pass this test per the sole discretion of the Director.
 - (f) Prior to plugging the well, the permittee must demonstrate external mechanical integrity as described in the Injection Well Plugging Plan and that meets the requirements of 40 C.F.R. § 146.92(a).
 - (g) The Director may require the use of other tests to demonstrate mechanical integrity other than those listed above, provided that the type of test has the written approval of the Administrator pursuant to requirements at 40 C.F.R. § 146.89(e).
3. **Prior Notice, MIT Procedures and Reporting** –
- (a) The permittee must notify the Director in an electronic format of intent to demonstrate mechanical integrity at least 30 days prior to such demonstration. At the discretion of the Director a shorter time period may be allowed.
 - (b) The mechanical integrity tests and procedures are listed in Attachment C. If the

permittee wishes to use tests and procedures not listed, they must be approved by the Director in advance of the testing. Use of non-approved tests and procedures may result in disqualification of the tests.

- (c) Reports of mechanical integrity demonstrations which include logs must include an interpretation of results by a knowledgeable log analyst. The permittee must report in an electronic format the results of a mechanical integrity demonstration within the time period specified in Section O of this permit.
4. **Gauge and Meter Calibration** – Prior to testing, the permittee must calibrate all gauges used in mechanical integrity demonstrations and other monitoring required by this permit. All equipment must read to an accuracy of not less than 0.5 percent of full scale. All equipment must be calibrated in the manner and frequency recommended by the manufacturer and at least within one year prior to each required test. The date of the most recent calibration must be noted on or near the gauge or meter. A copy of the calibration certificate must be submitted to the Director in an electronic format with the report of the test. Pressure gauge resolution must be no greater than five psi. Certain mechanical integrity and other testing may require greater accuracy and must be identified in the procedure submitted to the Director prior to the test.
5. **Loss of Mechanical Integrity** –
- (a) If the permittee or the Director finds that the well fails to demonstrate mechanical integrity during a test, or fails to maintain mechanical integrity during operation, or that a loss of mechanical integrity as defined by 40 C.F.R. § 146.89(a)(1) or (2) is suspected during operation (such as a significant unexpected change in the annulus or injection pressure), the permittee must:
 - (i) Cease injection in accordance with Section K(8), and Attachments C or F of this permit;
 - (ii) Take all steps reasonably necessary to determine whether there may have been a release of the injected carbon dioxide stream or formation fluids into any unauthorized zone. If there is evidence of potential USDW endangerment, the Emergency and Remedial Response Plan must be implemented (Attachment F of this permit);
 - (iii) Follow the reporting requirements as directed in Section O of this permit;
 - (iv) Restore and demonstrate mechanical integrity to the satisfaction of the Director and receive written approval from the Director prior to resuming injection; and
 - (v) Notify the Director in an electronic format when injection can be expected to resume.

- (b) If an automatic shutdown (*i.e.*, down-hole or at the surface) is triggered, the permittee must immediately investigate and identify as expeditiously as possible the cause of the shutdown. If, upon investigation, the well appears to be lacking mechanical integrity, or if the required monitoring indicates that the well may be lacking mechanical integrity, the permittee must take the actions listed above in Section L(5)(a)(i) through (v).
- (c) If the well loses mechanical integrity prior to the next scheduled test date, then the well must either be plugged or repaired and retested within 30 days of losing mechanical integrity. The permittee must not resume injection until mechanical integrity is demonstrated and the Director gives written approval to recommence injection in cases where the well has lost mechanical integrity.

6. **Mechanical Integrity for Confining Zone, Injection Zone, and Groundwater Monitoring Wells** – All monitoring wells must maintain internal and external mechanical integrity for the entirety of their operational life. No significant leaks in the casing can occur and require corrective actions. The determination of whether the monitoring well has mechanical integrity is at the discretion of the Director. Mechanical integrity is determined through testing and test procedures approved by the Director. Mechanical integrity tests and procedure for the confining zone and injection zone monitoring wells are outlined in the Testing and Monitoring Plan in Attachment C of this permit. Mechanical integrity testing for groundwater monitoring wells shall consist of periodic televising of the well casing. Testing and demonstration of monitoring wells must be conducted on the same schedule as the injection well. Other tests and/or procedures not listed in this plan will be considered by the Director for approval.
7. **Mechanical Integrity Testing on Request from Director** – The permittee must demonstrate mechanical integrity at any time upon written notification from the Director.

M. SEISMIC EVENT RESPONSE

The permittee must subscribe to the U.S. Geological Survey Earthquake Notification Service to receive notification of seismic events (both natural and induced) within 100 kilometers (≈ 62 miles) from the well. The midpoint between the surface-hole and bottom-hole locations shall be used as the center of the circle. The appropriate response to seismic events depends on the Moment Magnitude (M_w) of the seismic event according to the following protocol.

1. **Seismic events not recorded or M_w less than 3.5:** Continue normal operations.
2. **Seismic events with M_w equal to or greater than 3.5 but less than 5.0:** The permittee must notify the Director of any such event within 24 hours, providing information on the status of the injection site. If the annulus pressure of the well decreases below the set alarm, injection operations must cease. In that situation, within 30 days the permittee must evaluate the internal mechanical integrity of the well by performing tests in accordance with Section L(2)(a) of this permit. If the well fails the mechanical integrity test or the permittee identifies

any problems with the injection system that might impact a USDW, the injection well must remain shut-in and the permittee must submit a report in electronic format as soon as possible but no later than five (5) days from the time the permittee becomes aware of the circumstances. The report shall contain a description of the circumstances and if the situation has not been corrected, the anticipated time it is expected to continue; and steps taken or planned to reduce, eliminate, and prevent recurrence of the circumstances. Upon completion of the steps to ensure mechanical integrity and the subsequent mechanical integrity demonstration, the permittee must submit the results and any other required documentation to the Director in an electronic format. If after the testing the well demonstrates mechanical integrity and issues that might impact USDWs are not identified, the permittee must provide a report of those findings to the Director for review and approval. Injection operations cannot resume until the Director grants approval to recommence injection.

3. **Seismic Events equal to or greater than M_w 5.0:** Injection operations must immediately cease. The permittee must notify the Director of any such event within 24 hours, providing information on the status of the injection well system. If the annulus pressure decreased below the well's set alarm before shutting in the well, then the permittee must evaluate the internal mechanical integrity of the well by performing tests in accordance with Section L(2)(a) of this permit. The permittee must also perform an evaluation of the external mechanical integrity of the well in accordance with Section L(2)(b) of this permit. If the well fails either the internal or external mechanical integrity test or the permittee identifies any problems with the system that might impact a USDW, the injection well must remain shut-in and the permittee must submit a report in electronic format as soon as possible but no later than 30 days from the time the permittee becomes aware of the circumstances. The report shall contain a description of the failure and if the failure has not been corrected, the anticipated time it is expected to continue, and steps taken or planned to reduce, eliminate, and prevent recurrence of the failure. Upon completion of the steps to ensure mechanical integrity and the subsequent mechanical integrity demonstration, the permittee must submit the results and any other required documentation to the Director. Injection operations cannot resume until the Director grants approval to recommence injection.

N. TESTING AND MONITORING REQUIREMENTS

The specific measurement and reporting frequencies are listed in Attachment C.

1. **Testing and Monitoring Plan** –

- (a) The permittee must maintain and comply with the approved Testing and Monitoring Plan included as Attachment C of this permit and with the requirements at 40 C.F.R. §§ 144.51(j), 146.88(e), and 146.90, and any modifications required by the Director after the effective date of this permit. The Testing and Monitoring Plan is an enforceable condition of this permit. Samples and measurements taken for the purpose of monitoring must be representative of the monitored activity. Procedures for all testing and monitoring under this permit must be submitted to the Director in an electronic format for approval at least 30 days prior to the test if they plan to deviate from the procedures outlined in the Testing and Monitoring Plan in

Attachment C of this permit. When the test report is submitted, a full explanation must be provided as to why any approved procedures were not followed. If the approved procedures were not followed, EPA may take an appropriate action, including but not limited to, requiring the permittee to re-run the test.

- (b) The permittee must update the Testing and Monitoring Plan as required by 40 C.F.R. § 146.90(j) to incorporate monitoring and operational data and in response to AoR reevaluations required under Section G(1) of this permit or demonstrate to the Director that no update is needed. The amended Testing and Monitoring Plan or demonstration must be submitted to the Director in an electronic format within one year of an AoR reevaluation; following any significant changes to the facility such as addition of monitoring wells or newly permitted injection wells within the AoR; or when required by the Director.
- (c) Following each update of the Testing and Monitoring Plan or a demonstration that no update is needed, the permittee must submit the resultant information in an electronic format to the Director for review and approval of the results. Once approved by the Director, the revised Testing and Monitoring Plan will become an enforceable condition of this permit.
2. **Carbon Dioxide Stream Analysis** – The permittee must analyze the carbon dioxide stream with sufficient frequency to yield data representative of its chemical and physical characteristics, as described in the Testing and Monitoring Plan and to meet the requirements of 40 C.F.R. § 146.90(a).
3. **Continuous Monitoring** –The permittee must install and use continuous recording devices to monitor: the injection pressure (at surface and at injection interval), injection flow rate, injection mass, pressure on the annulus between the tubing and the long string of casing, annulus fluid level, and temperature (at surface and at injection interval). This monitoring must be performed as described in the Testing and Monitoring Plan to meet the requirements of 40 C.F.R. § 146.90(b). The permittee must maintain for EPA's inspection at the facility an appropriately scaled, continuous record of these monitoring results as well as original files of any digitally recorded information pertaining to these operations.
4. **Groundwater Monitoring Above the Confining Zone** – The permittee shall monitor groundwater quality and geochemical changes above the confining zone that may be a result of carbon dioxide movement through the confining zone and additional identified geologic units. All monitoring conducted must be performed for the parameters identified in the approved Testing and Monitoring Plan at the locations and depths, and at frequencies described in the Testing and Monitoring Plan to meet the requirements of 40 C.F.R. § 146.90(d).
5. **Carbon Dioxide Plume and Pressure Front Tracking** –The permittee must track the extent of the carbon dioxide plume and pressure front using direct and indirect monitoring methods as described in the approved Testing and Monitoring Plan and in

accordance with 40 C.F.R. § 146.90(g). The permittee is required to conduct this monitoring in order to detect and locate the carbon dioxide pressure front and the dissolved carbon dioxide plume and the data will be used to calibrate the AoR model to determine whether modifications to the AoR need to be made. The data collected will be used to monitor the location of the plume and pressure front, evaluate its movement through time, and to compare to the plume and pressure front predictions of the AoR model

- (a) **Direct Methods** – The permittee must use the deep monitoring point to continuously record the pressure and temperature of the injection zone formation to track the position of the carbon dioxide pressure front and to collect fluid samples from the injection zone formation to track the position of the carbon dioxide plume described in the approved Testing and Monitoring Plan and to meet the requirements of 40 C.F.R. § 146.90(g)(1).
 - (b) **Indirect Methods** – The permittee must use the indirect monitoring methods to track the position of the carbon dioxide plume and pressure front as described in the Testing and Monitoring Plan and to meet the requirements of 40 C.F.R. § 146.90(g)(2).
6. **Corrosion Monitoring** – The permittee must perform corrosion monitoring of the well construction materials for loss of mass, thickness, cracking, pitting, and other signs of corrosion on a quarterly basis using the procedures described in the Testing and Monitoring Plan and in accordance with 40 C.F.R. § 146.90(c). This ensures that the well components meet the minimum standards for material strength and performance set forth in 40 CFR 146.86(b).
7. **External Mechanical Integrity Testing** – The permittee must demonstrate external mechanical integrity annually as described in the approved Testing and Monitoring Plan and must comply with Section L of this permit in order to meet the requirements of 40 C.F.R. §§ 146.89 and 146.90.
8. **Pressure Fall-Off Test** – The permittee shall conduct a pressure fall-off test at least once every five years unless more frequent testing is required by the Director based on site-specific information. The test shall be performed as described in the Testing and Monitoring Plan to meet the requirements of 40 C.F.R. § 146.90(f).
9. **Surface Air and/or Soil Gas Monitoring** – In addition to the testing and monitoring outlined in this permit and in the applicable regulations, the Director may require surface air monitoring and/or soil gas monitoring to detect potential movement of carbon dioxide that could endanger a USDW. Should the Director deem this monitoring necessary, the Testing and Monitoring Plan must be amended to be reflective of the frequency and locations the Director requires and must meet the requirements of 40 C.F.R. § 146.90(h).
10. **Additional Monitoring** – If required by the Director as provided in 40 C.F.R. §

146.90(i), the permittee must perform any additional monitoring determined to be necessary to support, upgrade, and improve computational modeling of the AoR evaluation required under 40 C.F.R. § 146.84(c) and to determine compliance with standards under 40 C.F.R. §§144.12 or 146.86(a). This monitoring must be performed as described in a modification to the Testing and Monitoring Plan.

O. REPORTING AND RECORDKEEPING

The permittee must submit reports at frequencies described in the approved Testing and Monitoring Plan, and as required by this permit. Reports must contain all the data and information required to be monitored, gathered and reported by this permit and meet the requirements of 40 C.F.R. §§ 144.17, 144.51(l), 144.54(c), and 146.91.

1. **Electronic Reporting** – All reports, submittals, notifications, correspondence to the EPA, and records made and maintained by the permittee under this permit must be in an electronic format. The permittee must electronically submit all required reports to an address or location as determined by the Director.

2. **Semi-Annual Reports** – The permittee must submit reports on a semi-annual basis in accordance with 40 C.F.R. § 146.91(a). The reporting period for semi-annual reports will be from January 1 through June 30 and from July 1 through December 31. Reports must be submitted within 30 days of the end of each reporting period. Semi-annual reports must include all data collected on a continuous, daily, monthly, quarterly and semi-annual basis as described in the approved Testing and Monitoring Plan. The second semi-annual report for each year must include all data collected on an annual basis as described in the approved Testing and Monitoring Plan. Reports must contain the following information and data, as well as all other information and data collected not listed below, but as described in the approved Testing and Monitoring Plan:
 - (a) Any changes to the physical, chemical, and other relevant characteristics of the carbon dioxide stream from the proposed operating data;
 - (b) Monthly average, maximum, and minimum values for injection pressure, flow rate and daily volume, temperature, and annular pressure;
 - (c) A description of any event that exceeds operating parameters for annulus pressure or injection pressure specified in this permit;
 - (d) A description of any event which triggers the shut-off systems required in Section(K)(6) of this permit pursuant to 40 C.F.R. § 146.88(e), and the response taken;
 - (e) The monthly volume and mass of the carbon dioxide stream injected over the reporting period and the volume and mass injected cumulatively over the life of the project;

- (f) Monthly annulus fluid volume added or produced; and
- (g) Results of the continuous monitoring required in Section N(3) including:
 - (i) A tabulation of: (1) daily maximum injection pressure, (2) daily minimum annulus pressure, (3) daily minimum value of the difference between simultaneous measurements of annulus and injection pressure, (4) daily volume and mass, (5) daily maximum flow rate, and (6) average annulus tank fluid level; and
 - (ii) Graph(s) of the continuous monitoring as required in Section N(3) of this permit, or of daily average values of these parameters. The injection pressure, injection volume and mass and flow rate, annulus fluid level, annulus pressure, and temperature must be submitted on one or more graphs, using contrasting symbols or colors, or in another manner approved by the Director.
- (h) Results of any additional monitoring identified in the Testing and Monitoring Plan and described in Section N of this permit.

3. **24-Hour Reporting** –

- (a) The permittee must report to the Director any permit noncompliance which may endanger human health or the environment and any events that require implementation of actions in the Emergency and Remedial Response Plan (Attachment F of this permit). Any information must be provided orally within 24 hours from the time the permittee becomes aware of the circumstances. Such verbal reports must include, but need not be limited to the following information:
 - (i) Any evidence that the injected carbon dioxide stream or associated pressure front may cause an endangerment to a USDW, or any monitoring or other information which indicates that any contaminant may cause endangerment to a USDW;
 - (ii) Any noncompliance with a permit condition, or malfunction of the injection system, which may cause fluid migration into or between USDWs;
 - (iii) Any triggering of the shut-off system required in Section (K)(6) of this permit (i.e., down-hole or at the surface);
 - (iv) Any failure to maintain mechanical integrity;
 - (v) Pursuant to compliance with the requirement at 40 C.F.R. § 146.90(h) for surface air/soil gas monitoring or other monitoring technologies, if required by the Director, any release of carbon dioxide to the atmosphere or biosphere; and

- (vi) Actions taken to implement appropriate protocols outlined in the Emergency and Remedial Response Plan (Attachment F of this permit).
- (b) A written submission must be provided to the Director in an electronic format within five days of the time the permittee becomes aware of the circumstances described in Section O(3)(a) of this permit. The submission must contain a description of the noncompliance or emergency, or remedial response and its cause; the period of noncompliance, emergency, or remedial response, including exact dates and times, and, if the noncompliance has not been corrected, the anticipated time it is expected to continue as well as actions taken to implement appropriate protocols outlined in the Emergency and Remedial Response Plan (Attachment F of this permit); and steps taken or planned to reduce, eliminate and prevent recurrence of the noncompliance or emergency or condition requiring remedial response.
4. **Reports on Well Tests and Workovers** – Report, within 30 days, the results of:
- (a) Periodic tests of mechanical integrity;
- (b) Any well workover, including stimulation;
- (c) Any other test of the injection well conducted by the permittee if required by the Director; and
- (d) Any test of any monitoring well required by this permit.
5. **Advance Notice Reporting** –
- (a) **Well Tests** – The permittee must give at least 30 days advance written notice to the Director in an electronic format of any planned workover, stimulation, or other well test.
- (b) **Planned Changes** – The permittee must give written notice to the Director in an electronic format, as soon as possible, of any planned physical alterations or additions to the permitted facility. An analysis of any new injection fluid must be submitted to the Director for review and written approval at least 30 days prior to injection; this approval may result in a permit modification.
- (c) **Anticipated Noncompliance** – The permittee must give at least 14 days advance written notice to the Director in an electronic format of any planned changes in the permitted facility or activity which may result in noncompliance with permit requirements.
6. **Additional Reports** –

- (a) **Compliance Schedules** – Reports of compliance or noncompliance with, or any progress reports on, interim and final requirements contained in any compliance schedule of this permit must be submitted in an electronic format by the permittee no later than 30 days following each schedule date.
- (b) **Transfer of Permits** – This permit is not transferable to any person except after notice is sent to the Director in an electronic format at least 30 days prior to transfer and the requirements of 40 C.F.R. §144.38(a) have been met. Pursuant to requirements at 40 C.F.R. 144.38(a), the Director will require modification or revocation and reissuance of the permit to change the name of the permittee and incorporate such other requirements as may be necessary under the SDWA. All FR cost estimates, documentation, and instruments as required by 40 C.F.R. § 146.85 and by Section H of this permit must be updated and provided to the Director by any new owner of the well.
- (c) **Other Noncompliance** – The permittee must report in an electronic format all other instances of noncompliance not otherwise reported with the next monitoring report. The reports must contain the information listed in Section O(3)(b) of this permit.
- (d) **Other Information** – When the permittee becomes aware of failure to submit any relevant facts in the permit application or that incorrect information was submitted in a permit application or in any report to the Director, the permittee must submit such facts or corrected information in an electronic format within 10 days of discovery in accordance with 40 C.F.R. §144.51(1)(8).
- (e) **Report on Permit Review** – Within 30 days of receipt of this permit, the permittee must certify to the Director in an electronic format that he or she has read and is personally familiar with all terms and conditions of this permit.

7. **Records and Record Retention** –

- (a) The permittee must retain records and all monitoring information, including all calibration and maintenance records and all original chart recordings for continuous monitoring instrumentation and copies of all reports required by this permit (including records from pre-injection, active injection, and post-injection phases) for a period of at least 10 years from collection.
- (b) The permittee must maintain records of all data required to complete the permit application form for this permit and any supplemental information (e.g., modeling inputs for AoR delineations and reevaluations, plan modifications) submitted under 40 C.F.R. §§144.27, 144.31, 144.39, and 144.41 until least 10 years after site closure.
- (c) The permittee must retain records concerning the nature and composition of all injected fluids until 10 years after site closure.

- (d) The retention periods specified in Section O(7)(a) through (c) of this permit may be extended by request of the Director at any time. The permittee must continue to retain records after the retention period specified in Section O(7)(a) through (c) of this permit or any requested extension thereof expires unless the permittee delivers the records to the Director or obtains written approval from the Director to discard the records.
- (e) Records of monitoring information must include:
- (i) The date, exact place, and time of sampling or measurements;
 - (ii) The name(s) of the individual(s) who performed the sampling or measurements;
 - (iii) A precise description of both sampling methodology and the handling of samples;
 - (iv) The date(s) analyses were performed;
 - (v) The name(s) of the individual(s) who performed the analyses;
 - (vi) The analytical techniques or methods used; and
 - (vii) The results of such analyses.

P. WELL PLUGGING, POST-INJECTION SITE CARE, AND SITE CLOSURE

The permittee must maintain and comply with the approved Well Plugging Plan (Attachment D) and the approved Post Injection Site Care and Site Closure Plan (Attachment E) and must comply with the requirements of 40 C.F.R. §§ 146.92 and 146.93. The Well Plugging Plan and the Post-Injection Site Care and Site Closure Plan are enforceable conditions of this permit.

1. **Well Plugging Plan Revisions** – If data indicates and the permittee deems it necessary, or if the Director requires the approved plans in Attachments C and D of this permit to be modified, revised plan(s) must be submitted in an electronic format to the Director for review and written approval. Any amendments to the Well Plugging Plan and/or the Post-Injection Site Care and Site Closure plan must be approved by the Director and must be incorporated into the permit and are subject to the permit modification requirements at 40 C.F.R. §§ 144.39 and/or 144.41.
2. **Required Activities Prior to Plugging** – The permittee must flush the well with an inert buffer fluid, determine the post-injection bottom hole pressure, and perform final internal and external mechanical integrity tests prior to injection well plugging. The internal and external mechanical integrity tests must be performed as required by Section L of this permit.
3. **Notice of Plugging and Abandonment** – The permittee must notify the Director in writing in an electronic format pursuant to 40 C.F.R. § 146.92(c), at least 60 days

before plugging, conversion or abandonment of the well. A shorter notice period may be allowed at the discretion of the Director.

4. **Plugging and Abandonment Approval and Report** –

- (a) The permittee must receive written approval from the Director before plugging the well and must plug and abandon the well as required by 40 C.F.R. § 146.92, as described in the approved Well Plugging Plan (Attachment D of this permit).
- (b) Within 60 days after plugging, the permittee must submit in an electronic format a plugging report to the Director. The report must be signed and certified by the permittee per 40 C.F.R. § 144.32 and by the person who performed the plugging operation (if other than the permittee.) The permittee must retain the well plugging report in an electronic format for 10 years following site closure. The report must include:
 - (i) A statement that the well was plugged in accordance with the approved Well Plugging Plan (Attachment D of this permit); or
 - (ii) If the actual plugging differed from the approved plan, a statement describing the actual plugging and an updated plan specifying the differences from the plan previously submitted and explaining why the Director should approve such deviation. If the Director determines that a deviation from the plan incorporated in this permit may endanger underground sources of drinking water, the permittee must replug the well as required by the Director.

5. **Temporary Abandonment** – If the permittee ceases injection for more than 24 consecutive months, the well is considered to be in a temporarily abandoned status, and the permittee must plug and abandon the well in accordance with the approved Well Plugging Plan, 40 C.F.R. § 144.52 (a)(6) and 146.92, or make a demonstration of non-endangerment of this well that is satisfactory to the Director while it is in temporary abandonment status. During any periods of temporary abandonment or disuse, the well must be tested to ensure that it maintains mechanical integrity, in compliance with the requirements and frequency specified in Section L(2) of this permit. The permittee must continue to comply with the conditions of this permit, including all monitoring and reporting requirements in compliance with all of the requirements of this permit and all applicable regulations.

6. **Post-Injection Site Care and Site Closure Plan** – The permittee must maintain and comply with the Post-Injection Site Care and Site Closure Plan in Attachment E of this permit and comply with the requirements of 40 C.F.R. § 146.93. The Post-Injection Site Care period is the length of time anticipated to demonstrate that the carbon dioxide injection poses no threat to USDWs and is an enforceable condition of this permit.

- (a) Upon cessation of injection, the permittee must either submit in electronic format for the Director's approval an amended Post-Injection Site Care and Site Closure Plan

or demonstrate through monitoring data and modeling results that no amendment to the plan is needed.

- (b) At any time during the life of the project, the permittee may modify and resubmit in an electronic format the Post-Injection Site Care and Site Closure Plan for the Director's approval per 40 C.F.R. §146.93(a)(3). The permittee may, as part of such modifications to the Plan, request a modification to the post-injection site care timeframe that includes documentation of the information at 40 C.F.R. § 146.93(c)(1).
- (c) The monitoring as outlined in the approved Post-Injection Site Care and Site Closure Plan must define the position of the carbon dioxide plume and pressure front, provide a comparison of data collected to the predictions made by the AoR model, and demonstrate that USDWs are not being endangered per 40 CFR 146.90 and 146.93.
- (d) Prior to authorization for site closure, the permittee must submit to the Director for review and approval, in an electronic format, a demonstration, based on information collected pursuant to Section P(6)(b) of this permit, that the carbon dioxide plume and the associated pressure front do not pose an endangerment to USDWs and that no additional monitoring is needed to ensure that the project does not pose an endangerment to USDWs, as required under 40 C.F.R. § 146.93(b)(3). The Director reserves the right to amend the post-injection site monitoring requirements (including an extension of the monitoring period) if there is a concern that USDWs are at risk of endangerment.
- (e) The permittee must notify the Director in an electronic format at least 120 days before site closure. At this time, if any changes to the approved Post-Injection Site Care and Site Closure Plan in Attachment E of this permit are proposed, the permittee must submit a revised plan.
- (f) After the Director has authorized site closure, the permittee must plug all monitoring wells as specified in Attachments D and E of this permit in a manner which will not allow movement of injection or formation fluids that endangers a USDW. The permittee must also restore the site to its pre-injection condition.
- (g) The permittee must submit a site closure report in an electronic format to the Director within 90 days of site closure. The report must include the information specified at 40 C.F.R. § 146.93(f).
- (h) The permittee must record a notation on the deed to the facility property or any other document that is normally examined during a title search that will in perpetuity provide any potential purchaser of the property the information listed at 40 C.F.R. § 146.93(g).
- (i) The permittee must retain for 10 years following site closure an electronic copy of

the site closure report, records collected during the post-injection site care period, and any other records required under 40 C.F.R. § 146.91(f)(4). The permittee must deliver the records in an electronic format to the Director at the conclusion of the retention period.

Q. EMERGENCY AND REMEDIAL RESPONSE

The Emergency and Remedial Response Plan describes actions the permittee must take to address movement of the injection or formation fluids that may cause an endangerment to a USDW during construction, operation, and post-injection site care periods. The permittee must maintain and comply with the approved Emergency and Remedial Response Plan (Attachment F of this permit), which is an enforceable condition of this permit, and with 40 CFR 146.94.

1. If the data collected indicates evidence that the carbon dioxide plume and or pressure front may cause endangerment to a USDW, the permittee must:
 - (a) Cease injection in accordance with Sections K(8) and Attachments C or F of this permit;
 - (b) Take all reasonable steps necessary to identify and characterize any release from the underground injection system;
 - (c) Notify the Director within 24 hours; and
 - (d) Implement the approved Emergency and Remedial Response Plan in (Attachment F of this permit) approved by the Director.
2. At the frequency specified in the Area of Review and Corrective Action Plan Section G of this permit or more frequently if the monitoring and operational data warrant, the permittee must review and update the Emergency and Remedial Response Plan as required at 40 C.F.R. § 146.94(d) or demonstrate to the Director that no update is needed. The permittee must also incorporate monitoring and operational data and in response to AoR reevaluations required under Section G.2 of this permit or demonstrate to the Director that no update is needed. The amended Emergency and Remedial Response Plan or demonstration must be submitted to the Director in an electronic format within one year of an AoR reevaluation, following any significant changes to the facility such as the addition of injection wells, or when required by the Director. If the amendments to the Emergency and Remedial Response Plan cause the cost estimates to change, then new FR must be submitted for review and approval by the Director in accordance with Section H of this permit.
3. Following each update of the Emergency and Remedial Response Plan or a demonstration that no update is needed, the permittee must submit the resultant information in an electronic format to the Director for review and confirmation of the results. Once approved by the Director, the revised Emergency and Remedial Response

Plan will become an enforceable condition of this permit.

R. COMMENCING INJECTION

The permittee may not commence injection until:

1. Results of the formation testing and logging program as specified in Section J of this permit and in 40 C.F.R. § 146.87 are submitted to the Director in an electronic format and subsequently reviewed and approved by the Director;
2. Mechanical integrity of the well has been demonstrated in accordance with 40 C.F.R. § 146.89(a)(1) and (2), and in accordance with Section L(1) through (3) of this permit;
3. The completion of corrective action required by the Area of Review and Corrective Action Plan found in Attachment B of this permit in accordance with 40 C.F.R. § 146.84;
4. All requirements at 40 C.F.R. § 146.82(c) have been met, including but not limited to reviewing and updating of the Area of Review and Corrective Action, Testing and Monitoring, Well Plugging, Post-Injection Site Care and Site Closure, and Emergency and Remedial Response plans to incorporate final site characterization information, final delineation of the AoR, and the results of pre-injection testing, and information has been submitted in an electronic format, reviewed and approved by the Director;
5. Construction is complete and the permittee has submitted to the Director in an electronic format a notice that completed construction is in compliance with 40 C.F.R. § 146.86 and Section I of this permit;
6. The Director has inspected or otherwise reviewed the injection well and all submitted information and finds it is in compliance with the conditions of the permit;
7. The Director has approved demonstration of the alarm system and shut-off system under Section K.6 of this permit; and.
8. The Director has given written authorization to commence injection.

ATTACHMENTS

These attachments include, but are not limited to, permit conditions and plans concerning operating procedures, monitoring and reporting, as required by 40 CFR Parts 144 and 146. The permittee must comply with these conditions and adhere to these plans as they are approved by the Director by their incorporation into this permit.

- A. SUMMARY OF OPERATING REQUIREMENTS**
- B. AREA OF REVIEW AND CORRECTIVE ACTION PLAN**
- C. TESTING AND MONITORING PLAN**
- D. WELL PLUGGING PLANS**
- E. POST-INJECTION SITE CARE AND SITE CLOSURE PLAN**
- F. EMERGENCY AND REMEDIAL RESPONSE PLAN**
- G. PRE-INJECTION TESTING PLAN**
- H. WELL CONSTRUCTION DETAILS**
- I. FINANCIAL ASSURANCE DEMONSTRATION**
- J. STIMULATION PROGRAM**

ATTACHMENT A: SUMMARY OF REQUIREMENTS
OPERATING AND REPORTING CONDITIONS

Facility Information

Facility name: Wabash Carbon Services
WVCCS1 and WVCCS2

Facility address: 444 W. Sandford Ave, West Terre Haute, IN 47885

Well location: WVCCS1 Clinton, Vermillion County, Indiana
39 37' 27.88" N, 87 29 19.17" W
(Decimal Degrees X, Y: -87.48866, 39.62441)
WVCCS2 West Terre Haute, Vigo County, Indiana
39 33' 3.72" N, 87 29' 16.60" W
(Decimal Degrees X,Y: -87.48794, 39.55103)

Injection Well Operating Conditions, Parameters, and Limits:

PARAMETER/CONDITION	LIMITATION	UNIT
Maximum Injection Pressure - Surface	1296	psig
Maximum Injection Pressure - Injection Zone at 3970 feet bgs	2537	psig
Minimum Annulus Pressure	100	psig
Minimum Annulus Pressure/Tubing Differential (directly above and across packer)	100	psig
Carbon Dioxide Purity	>99.5	percent
Maximum Injection Rate	834,390	metric tons/year

During operation, the injection pressure will be measured at the wellhead and at the injection interval.

The maximum injection pressure of the injection zone, which serves to prevent confining-formation fracturing, was determined using a fracture gradient 0.71 psi/ft calculated from 7 step rate tests at the test hole conducted at the Wabash Carbon Services facility. The injection zone maximum injection pressure is calculated as 90% of the depth to the top of the injection zone multiplied by the fracture gradient. The surface maximum injection pressure is the injection zone maximum injection pressure minus the static head.

After the well is constructed, the Maximum Injection Pressure (MIP) will be recalculated, the MIP limit in the table above will be revised, using a fracture gradient measured from step rate tests that will be conducted in the injection well and the actual depth of the top of the injection zone.

Summary of Measurement, Assessment or Update, and Reporting Frequencies

ACTIVITY	MINIMUM RECORDING FREQUENCY	MINIMUM REPORTING FREQUENCY
CO ₂ stream characterization	Continuous	Semi-annually
Flow rate, injection mass, annulus pressure, annulus fluid level, and temperature	Continuous	Semi-annually
Injection Pressure at the wellhead	Continuous	Semi-annually
Injection Pressure at the Injection Zone	Continuous	Semi-annually
Injection Zone Fluid Monitoring	Annually	Annually
Corrosion monitoring	Quarterly	Semi-annually
External MIT	Annually	Annually
Fall-off Test	Every 5 years	Every 5 years
Above Confining Zone Plume Monitoring – Pennsylvanian System	Quarterly for first 2 years of operation; semi-annually thereafter	Annually
Above Confining Zone Plume Monitoring – Silurian System: Lowest USDW	Annually	Annually
Above Confining Zone Plume Monitoring Silurian System: Lowest USDW – Pulse Neutron Logging	Annually	Annually
Area of Review/Corrective Action Plan Assessment and Financial Responsibility Update	NA	Annually

Note: All testing and monitoring frequencies and methodologies are included in Attachment C (the Testing and Monitoring Plan) of this permit.

The report submittal schedule is (determined on a calendar basis):

- Semiannual Reports due on or before July 31st for first reporting period and January 31st for second reporting period
- Annual Reports due on or before February 15th
- 5-year reports due on or before February 15th of the end of the 5-year reporting cycle (from January 1st year 1 to December 31st year 5)

Start-up specifications and monitoring are outlined in the Testing and Monitoring Plan in Attachment C of this permit.

ATTACHMENT B: AREA OF REVIEW AND CORRECTIVE ACTION PLAN

Facility name: Wabash Carbon Services
WVCCS1 and WVCCS2

Facility address: 444 W. Sandford Ave, West Terre Haute, IN 47885

Well location: WVCCS1 Clinton, Vermillion County, Indiana
39 37' 27.88" N, 87 29 19.17" W
(Decimal Degrees X, Y: -87.48866, 39.62441)
WVCCS2 West Terre Haute, Vigo County, Indiana
39 33' 3.72" N, 87 29' 16.60" W
(Decimal Degrees X,Y: -87.48794, 39.55103)

Computational Modeling Approach

The Illinois State Geological Survey (ISGS) and Pacific Northwest National Laboratory (PNNL) authored this model using Subsurface Transport of Multiple Phase (STOMP) dynamic subsurface simulation software, Version 3.0. The model was built to dynamically simulate the flow of water and carbon dioxide throughout a twelve-year injection period and a subsequent 50-year Post Injection Site Care (PISC) period. The model accounts for multiphase (brine and carbon dioxide) flow and reactive transport.

The dynamic model simulation is based on porous media theory (Darcy's Law), and uses internal lookup tables to define gas properties vs. pressure. The carbon dioxide properties are based on an equation of state (Span and Wagner, 1996); the carbon dioxide/H₂O phase equilibria are based on a model developed by Spycher and Pruess, et al (Spycher et al., 2003; Spycher and Pruess, 2010). The multiphase flow of water and carbon dioxide was modeled to predict the movement of water, carbon dioxide, and pressure evolution within the reservoir. Carbon dioxide saturation and spatial pressure differentials over time were used to estimate and delineate the Area of Review (AoR). The selection of modeled processes is unlikely to change during AoR reevaluations.

Table 1: List of significant intervals above the Potosi Dolomite injection zone within the Wabash project area, as identified in the Wabash #1 test well.

Overlying Zone	Formation Thickness (ft)	Depth (ft)	Avg. Porosity (%) derived from logs	Estimated Avg. Permeability (mD)	Shale Thickness (ft)
Maquoketa Group	314	2,386	3.0	0.0001	312
Trenton Limestone	163	2,700	1.3	0.00000273	3.5

Platteville Group	379	2,863	1.2	0.00000475	16
Dutchtown Limestone	84	3,242	2.8	0.0000840	70.5
St. Peter Sandstone	28	3,326	4.0	0.0039	3.5
Shakopee Dolomite (upper)	346	3,354	2.8	0.022360406	101
Shakopee Dolomite (lower)	270	3,700	9.1	0.098032	71

Table 2: Proposed zone for injection reservoir at the Wabash project area, as identified in the Wabash #1 well.

Injection zone	Formation Thickness (ft)	Depth (ft)	Avg. Porosity (%)	Avg. Permeability (mD)	Reservoir Thickness (ft)
Oneota Dolomite	408	3,970	7.1	2.585488	408 (porosity not differentiated by depth)
Potosi Dolomite*	784	4,378	30 for tested interval (4,505 to 4,525 ft)	24,000 md-ft over 10 ft (2,400 md) from early short well test* Later and longer well tests suggest 45,000 md or higher.	Total of 149.5 ft greater than 10% porosity

Table 3: Model domain information.

Coordinate System	Illinois State Plane		
Horizontal Datum	North American Datum, 1927		
Coordinate System Units	Feet		
Zone	Eastern		
FIPZONE	1201	ADSZONE	3776
Coordinate of X min	680,048.56	Coordinate of X max	796,208.56
Coordinate of Y min	1,005,730.40	Coordinate of Y max	1,121,890.40
Elevation of top of domain	-2,386.0079	Elevation of bottom of domain	-5012.646

The dynamic reservoir simulation was run using PNNL's Subsurface Transport Over Multiple Phases

(STOMP) numerical simulation software, Version 3.0. The STOMP model, adapted from a static geologic model created in Petrel (discussed further in this document), was 22 miles \times 22 miles (35 km \times 35 km) laterally and 2,936 ft (895 m) vertically (Figure 9); the model incorporated a laterally variable hexahedral mesh, coarsening outward from the injection wells. The grid cells around the injection well were 660 ft \times 660 ft (201 m \times 201 m), gradually coarsening outward to a maximum cell size of 10,560 ft \times 10,560 ft (3219 m \times 3219 m) (Table 4). Total grid dimensions of the dynamic reservoir model were 112 by 112 cells laterally, and 47 vertical layers.

Table 4: Domain grid cell counts and dimensions.

Dx, Dy (ft)	Repeated Cells	Total cells	Total Dx, Dy (ft)
10,560	1	1	10,560
5,280	1	2	15,840
2,640	2	4	21,120
1,320	4	8	26,400
660	96	104	89,760
1,320	4	108	95,040
2,640	2	110	100,320
5,280	1	111	105,600
10,560	1	112	116,160

The model includes the Potosi Dolomite, underlying Davis Formation, and the overburden formations (listed in descending order) the Maquoketa Shale, Trenton Limestone, Platteville Limestone, Dutchtown Limestone, St. Peter Sandstone, Shakopee Dolomite, and Oneota Dolomite. Cell thickness varies by layer. Cells within the Potosi Dolomite layers are approximately 3 ft (1 m) thick.

Figure 1: Dynamic simulation model areal (22 miles × 22 miles) and vertical extent (2,936 ft), and included formations. In a clockwise direction beginning with the northeast, the center coordinates of the corner cells in the model are: NE: -87.28467, 39.74204; SE: -87.288718, 39.428321; SW: -87.69399, 39.429763; NW: -87.692678, 39.744527.

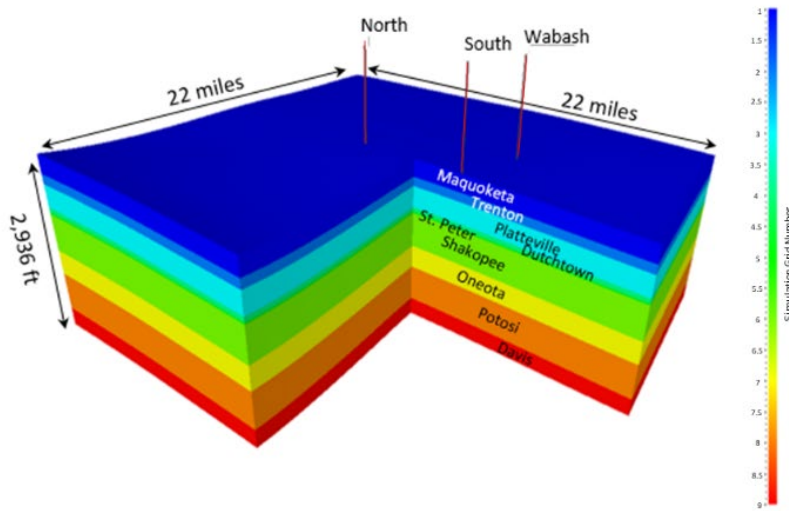

Table 5: Initial Modeled Conditions.

Parameter	Value or Range	Units	Corresponding Elevation (ft MSL)	Data Source
Temperature	108	F	4,500 ft.	Borehole temperature log
Formation pressure	1,940	psi	4,500 ft.	Pressure fall-off testing
Fluid density	63.33	lb/ft ³	4,500 ft.	Calculated from salinity, pressure, and temperature (SPE 18571)
Salinity	34,250	ppm	4,500 ft.	Swab sample from Potosi Dolomite

Table 6: Modeled Operating Parameters.

Operating Information	Injection Well 1	Injection Well 2
Location (global coordinates)		
X	-87.48864	-87.48792
Y	39.62437	39.55099
Model coordinates (ft)		
X	737945.4413	738399.8078
Y	1078177.671	1051450.913

Operating Information	Injection Well 1	Injection Well 2
No. of perforated intervals	1	1
Perforated interval (ft MSL)		
Z top	3,621	3,846
Z bottom	4,256	4,481
Wellbore diameter (in.)	8.75	8.75
Planned injection period		
Start	2024	2024
End	2036	2036
Injection duration (years)	12	12
Injection rate (tons/day)*	2,286	2,286

Figure 2: Maximum plume distance from injection wells over time, based on a 1% CO₂ saturation cutoff. The late uptick in plume radius (after stabilization) is due to coarseness of the outer grid cells.

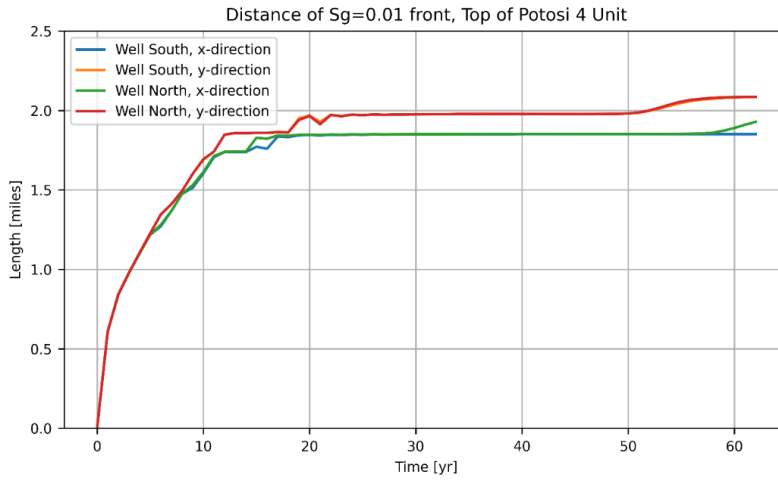

Figure 3: Plan view snapshots of predicted CO₂ plumes using a 1% gas saturation cutoff (white contour) for selected years. Twelve years of simulated injection begins at year 0.

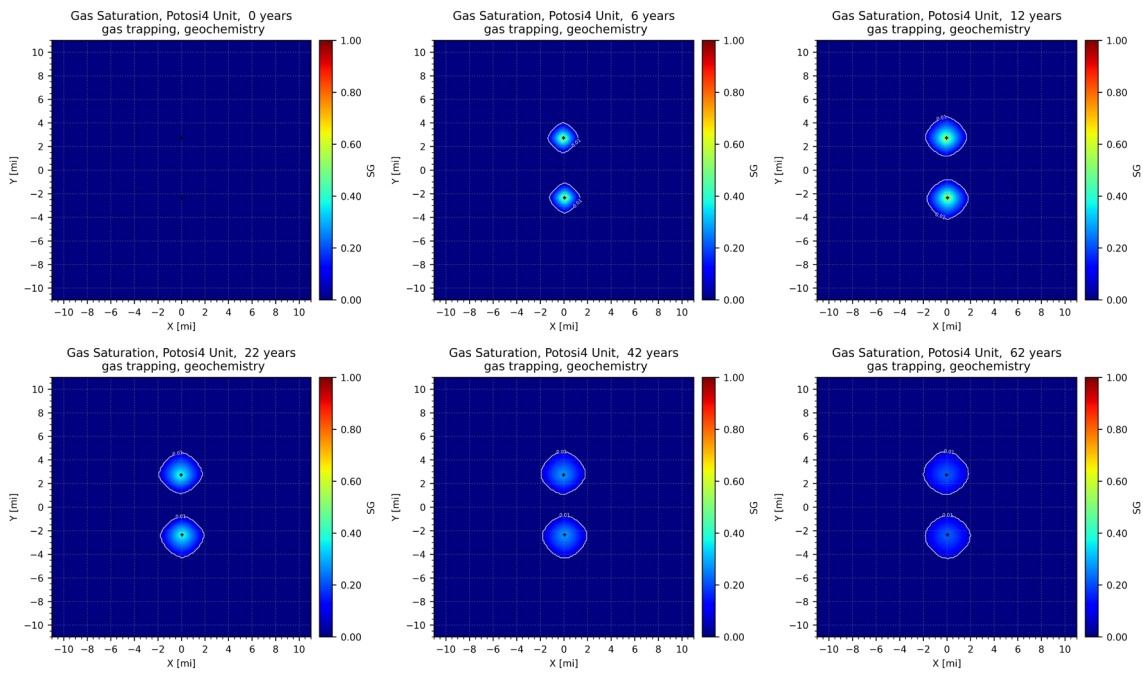

Figure 4: North-South cross-sectional snapshots of predicted CO₂ plumes for a 1% saturation cutoff at years 17, 22, 32, 42, 52, and 62. Twelve years of simulated injection begins at year 0. The injection wells are spaced five miles apart (WVCCS1: -87.48866, 39.62441; WVCCS2: -87.48794, 39.55103)

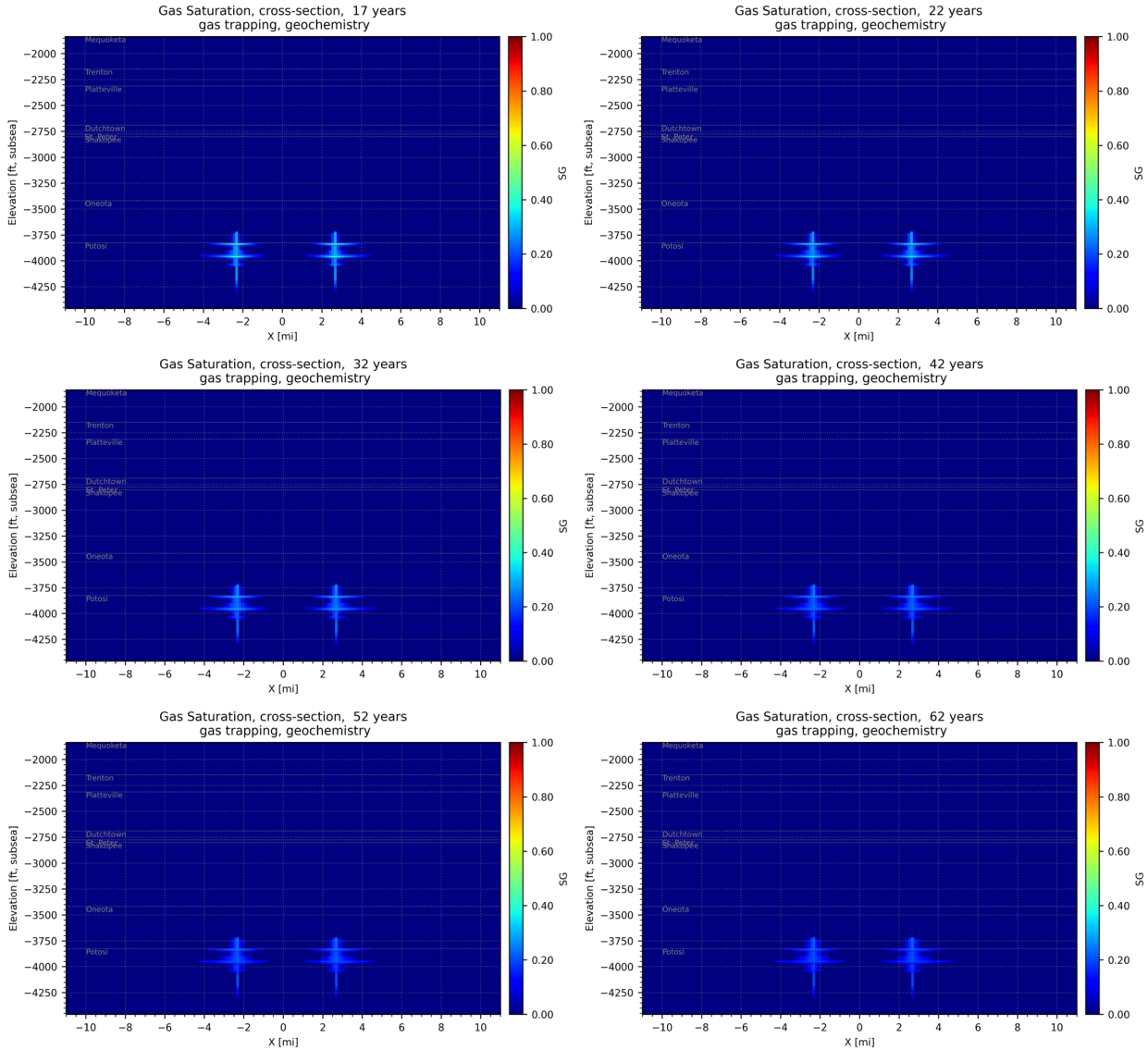

Figure 5: Maximum CO₂ plume extent after 12 years injection period and 50 years PISC period, in plan view and cross-section, using a 1% CO₂ saturation cutoff.

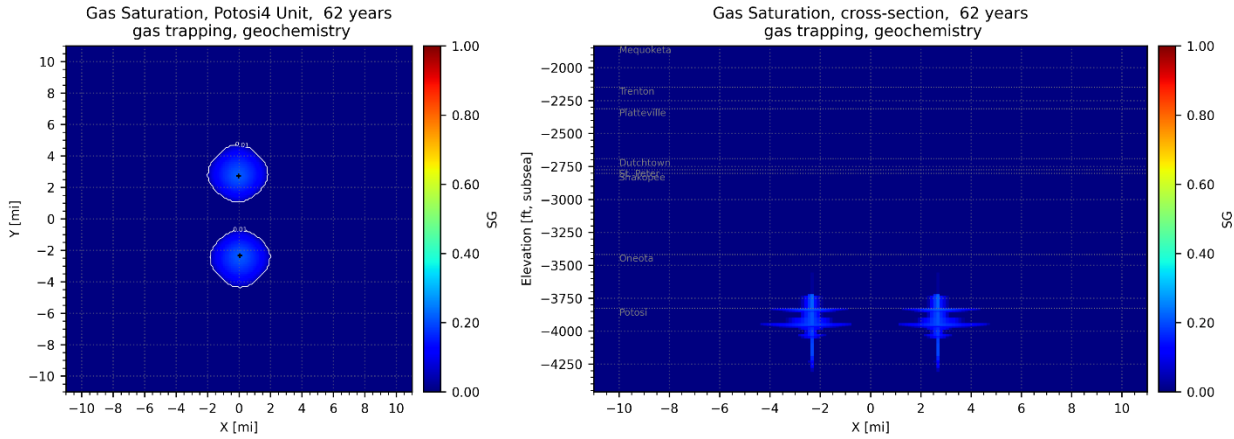
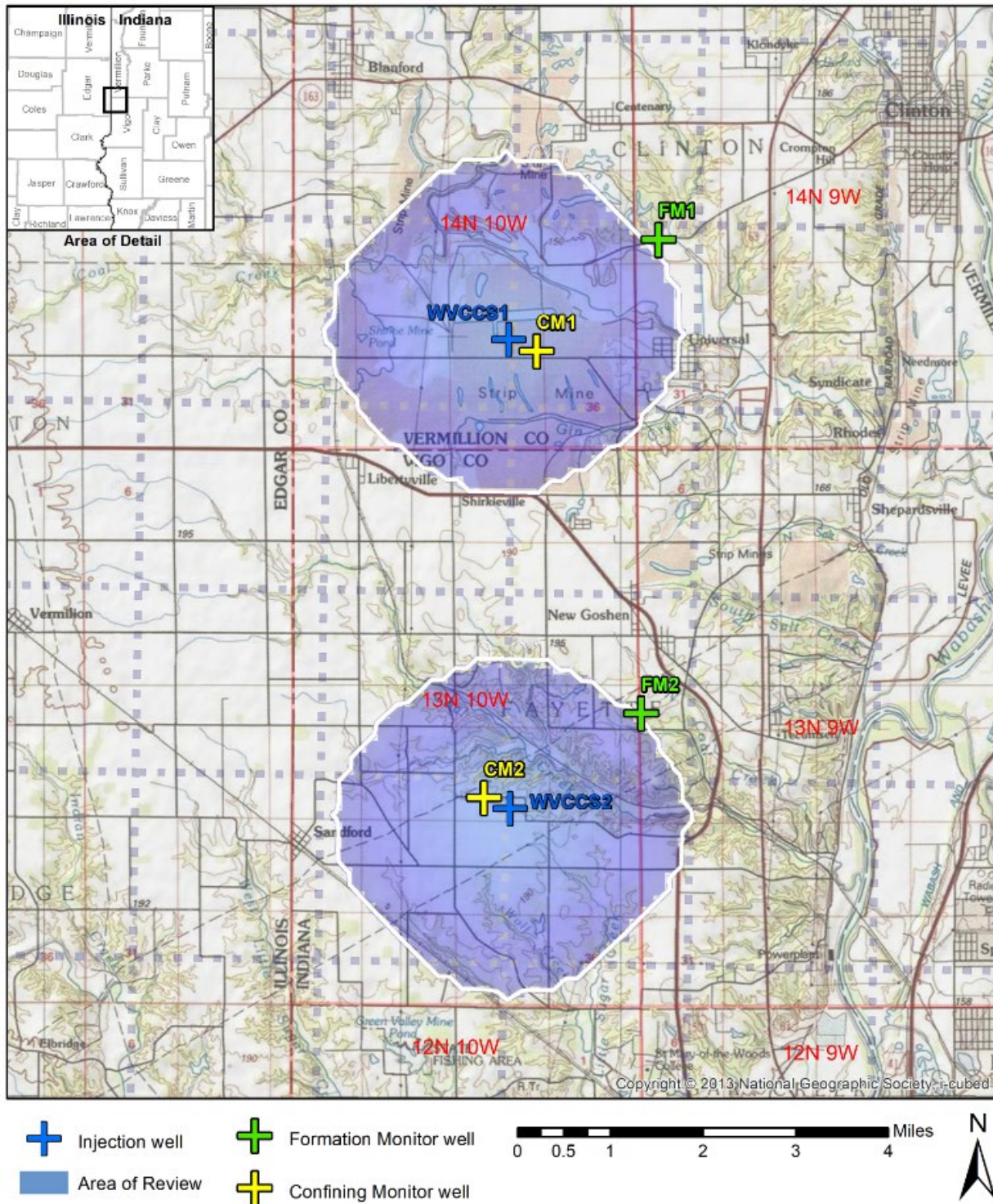

Table 7: Parameters and values used as input in the critical pressure calculation.

Parameter	Value	Units	Source
Pressure at the base of the lowermost USDW	1033.138	psi	Calculated using freshwater gradient of 0.433 psi/ft
Depth to base of lowermost USDW	2,386	ft	Base of Silurian (top of Maquoketa Group), Wabash #1 well
Depth to reservoir zone below lowermost USDW	2,783	ft	Middle of Trenton Limestone model layer, Wabash #1 well
Hydrostatic reservoir zone pressure below lowermost USDW	1,140	psi	Calculated from Wabash #1 Pressure Fall Off testing fracture gradient
Fluid density within the reservoir zone below lowermost USDW	64.3	lb/ft ³	Calculated from formation P and T, and deep resistivity, SP, and DPHI logs

Figure 6: Predicted maximum lateral extent of CO₂ plume(s) at year 62 (following 12 years injection and 50 years PISC period), based on a 1% gas saturation cutoff from the simulation grid results



Corrective Action Plan

No wells in the AoR penetrate the top of the Maquoketa Group (confining zone). Data collected as part of the Testing and Monitoring Plan will be evaluated to assess the prohibition of fluid movement and protection of USDWs. The Corrective Action Plan will be re-evaluated in accordance with this permit and all applicable regulations.

Reevaluation of CAP: Schedule and Criteria

WCS will take the following steps to evaluate project data and, if necessary, reevaluate the AoR. AoR reevaluations will be performed during the injection and post-injection phases at least every 5 years.

WCS will:

- 1) Review available monitoring data and compare it to the model predictions. WCS will analyze monitoring and operational data from the injection wells (WVCCS1 & WVCCS2), the formation monitor wells (FM1 & FM2) and confinement monitor wells (CM1 & CM2), and other sources to assess whether the predicted carbon dioxide plume migration is consistent with actual data. Monitoring activities to be conducted are described in the Testing and Monitoring Plan and the Post Injection Site Care (PISC) and Closure Plan. Specific steps of this review include:
 - a) Reviewing available data on the position of the carbon dioxide plume and pressure front (including pressure and temperature monitoring data and Reservoir Saturation Tool (RST) and seismic survey data). Specific activities will include:
 - i) Correlating data from seismic surveys (e.g., 2D and 3D surveys) to locate and track the movement of the carbon dioxide plume. A good correlation between the data sets will provide strong evidence in validating the model's ability to represent the storage system.
 - ii) Reviewing downhole reservoir pressure data collected from various locations and intervals using a combination of surface and downhole pressure gauges.
 - b) Reviewing groundwater chemistry monitoring data taken in the shallow (i.e., in the Pennsylvanian strata) monitoring wells, the Silurian/Devonian, and the St. Peter to verify that there is no evidence of excursion of carbon dioxide or brines that represent an endangerment to any USDWs.
 - c) Reviewing operating data, e.g., on injection rates and pressures, and verifying that it is consistent with the inputs used in the most recent modeling effort.
 - d) Reviewing any geologic data acquired since the last modeling effort, e.g., additional site characterization performed, updates of petrophysical properties from core analysis, etc. Identifying whether any new data materially differ from modeling inputs/assumptions.
- 2) Compare the results of computational modeling used for AoR delineation to monitoring data collected. Monitoring data will be used to show that the computational model accurately represents the storage site and can be used as a proxy to determine the plume's properties and size. WCS will

demonstrate this degree of accuracy by comparing monitoring data against the model's predicted properties (i.e., plume location, rate of movement, and pressure decay). Statistical methods will be employed to correlate the data and confirm the model's ability to accurately represent the storage site.

- 3) If the information reviewed is consistent with, or is unchanged from, the most recent modeling assumptions or confirms modeled predictions about the maximum extent of the plume and pressure front movement, WCS will prepare a report demonstrating that, based on the monitoring and operating data, no reevaluation of the AoR is needed. The report will include the data and results demonstrating that no changes are necessary.
- 4) If material changes have occurred (e.g., in the behavior of the plume and pressure front, operations, or site conditions) such that the actual plume or pressure front may extend beyond the modeled plume and pressure front, WCS will re-delineate the AoR. The following steps will be taken:
 - a) Revising the site conceptual model based on new site characterization, operational, or monitoring data.
 - b) Calibrating the model in order to minimize the differences between monitoring data and model simulations.
 - c) Performing the AoR delineation as described in the Computational Modeling section of the AoR and Corrective Action Plan.
- 5) Review wells in any newly identified areas of the AoR and apply corrective action to deficient wells. Specific steps include:
 - a) Identifying any new wells within the AoR that penetrate the confining zone and provide a description of each well type, location, depth, and date of plugging/completion.
 - b) Performing corrective action on all deficient wells that penetrate the primary confining zone using methods designed to prevent the movement of fluid into USDWs.
- 6) Prepare an annual report documenting the AoR reevaluation process, data evaluated, any corrective actions determined to be necessary, and the status of corrective action or a schedule for any corrective actions to be performed. The report will be submitted to EPA per the schedule for submitting annual reports in this permit. The report will include maps that highlight the similarities and differences in comparison with previous AoR delineations.

AoR Reevaluation Cycle

Upon commencement of injection, WCS will reevaluate the above described AoR at least once every 5 years during the injection and post-injection phases. More frequent reviews may occur if any of the events described in the next section occur.

Triggers for AoR Reevaluations Prior to the Next Scheduled Reevaluation

Unscheduled reevaluation of the AoR will be based on quantitative changes of the monitoring parameters in the deep monitoring wells, including unexpected changes in the following parameters: pressure, temperature, neutron saturation, and deep groundwater (>4,600 ft MD) constituent concentrations indicating that the actual plume or pressure front may extend beyond the modeled plume and pressure front. These changes include:

- 1) **Pressure:** Changes in pressure that are unexpected and outside three standard deviations from the average will trigger a new evaluation of the AoR.
- 2) **Pressure front arrival:** If the arrival time of the pressure front at the deep monitoring well differs significantly from the model projections (2 standard variations) or if the pressure and plume data recorded at the well differs materially from expectations, an AoR reevaluation will be performed.
- 3) **Change in pressure front not seen in monitoring well:** A reevaluation of the AoR will be triggered in the event that a secondary means of pressure front and/or plume distribution is detected (such as through seismic observation).
- 4) **AoR interaction:** Potential interaction of AoRs from different wells: Future modeling could indicate possible interactions of AoRs from different injection wells in the same injection zone. This has the potential to change the evaluation schedule (i.e., cause an unscheduled AoR reevaluation) to assess the possible impact of such an occurrence.
- 5) **Temperature:** Changes in temperature that are unexpected and outside three standard deviations from the average will trigger a new evaluation of the AoR.
- 6) **RST saturation:** Increases in carbon dioxide saturation that indicate the movement of the carbon dioxide into or above the confining zone will trigger a new evaluation of the AoR unless the changes are found to be related to the well integrity. (Any well integrity issues will be investigated and addressed.)
- 7) **Deep groundwater constituent concentrations:** Unexpected changes in fluid constituent concentrations that indicate movement of the carbon dioxide or brines into or above the confining zone will trigger a new evaluation of the AoR unless the changes are found to be related to the well integrity. (Any well integrity issues will be investigated and addressed.)
- 8) **Exceeding fracture pressure conditions:** Pressure in any of the injection or monitoring wells exceeding 90 percent of the geologic formation fracture pressure at the point of the measurement. This would be a violation of the permit conditions. The Testing and Monitoring Plan and the operating procedures in the Narrative provides a discussion of pressure monitoring and specific procedures that will be completed during the injection start-up period and continuing operations.
- 9) **Exceeding established baseline hydrochemical/physical parameter patterns:** A statistically significant difference between observed and baseline hydrochemical/physical parameter patterns (e.g., fluid conductivity, pressure, temperature) immediately above the confining zone. The Testing and Monitoring Plan provides extended information regarding how pressure, temperature, and fluid conductivity will be monitored.
- 10) **Compromise in injection well mechanical integrity:** A significant change in pressure within the protective annular pressurization system surrounding each injection well that indicates a loss of mechanical integrity at an injection well.

An unscheduled AoR reevaluation will also be needed if it is likely that the actual plume or pressure front may extend beyond the modeled plume and pressure front because any of the following has

occurred:

- 1) Seismic event greater than M3.5 within 100 km of either injection well.
- 2) If there is an exceedance of any Class VI operating permit condition (e.g., exceeding the permitted volumes of carbon dioxide injected); or
- 3) If new site characterization data changes the computational model to such an extent that the predicted plume or pressure front exceeds, or is expected to exceed, vertically or horizontally beyond the predicted AoR.

WCS will discuss any such events with the Director to determine if an AoR reevaluation is required. If an unscheduled reevaluation is triggered, WCS will perform the steps described at the beginning of this section of this Plan.

ATTACHMENT C: TESTING AND MONITORING PLAN**Facility Information**

Facility name: Wabash Carbon Services
WVCCS1 and WVCCS2

Facility address: 444 W. Sandford Ave, West Terre Haute, IN 47885

Well location: WVCCS1 Clinton, Vermillion County, Indiana
39 37' 27.88" N, 87 29 19.17" W
(Decimal Degrees X, Y: -87.48866, 39.62441)
WVCCS2 West Terre Haute, Vigo County, Indiana
39 33' 3.72" N, 87 29' 16.60" W
(Decimal Degrees X,Y: -87.48794, 39.55103)

This Testing and Monitoring Plan describes how Wabash Carbon Services (WCS) will monitor the Wabash CCS Project site pursuant to 40 C.F.R. § 146.90 and per Section N of this permit. The WVC CCS Project will utilize two injection wells to achieve the required annual injection rate. Due to this fact the Testing and Monitoring plan includes activities related to both injection wells and the associated carbon dioxide plumes. In addition to demonstrating that the well is operating as planned, the carbon dioxide plume and pressure front are moving as predicted, and that there is no endangerment to USDWs (Underground Sources of Drinking Water), WVC will use the monitoring data to validate and adjust the geological models used to predict the distribution of the carbon dioxide within the storage zone to support Area of Review (AoR) reevaluations and a non-endangerment demonstration.

Results of the testing and monitoring activities described below may trigger action according to the Emergency and Remedial Response Plan in Attachment F of this permit.

Testing and Monitoring Schedule of Sampling

All testing and monitoring will be conducted in accordance with the requirements of this permit and procedures will adhere to the quality assurance and surveillance plan (QASP) incorporated as Item #10 in the Administrative Record Index.

The schedule of sampling is as follows:

- 1) Continuous: Data is continuously sampled and recorded per the frequencies presented in Table 2 of this attachment
- 2) Quarterly: Sampling will take place within 5 days before the following dates each year: March 31st, June 30th, September 30th, December 31st.
- 3) Semi-annual: Sampling will take place within 5 days before June 30th and December 31st.
- 4) Annual: Sampling will take place within 45 days before January 1st of each year.

- 5) 5 Year: Sampling will take place every 5 years within 45 days before January 1st during injection and PISC period.

Measurement, Monitoring and Verification (MMV) Technologies

Two key objectives of any risk assessment evaluation and the development of a viable MMV plan are to:

- 1) Ensure Conformance by demonstrating that storage performance aligns with expectations regarding injectivity, capacity, and carbon dioxide behavior inside the geologic storage reservoir
- 2) Ensure Containment, which demonstrates security of carbon dioxide storage to protect human health, groundwater resources, hydrocarbon resources (if present), and the environment and meets regulatory requirements.

Reporting procedures

WCS will report the results of all testing and monitoring activities to the EPA in compliance with this attachment, the requirements under 40 C.F.R. § 146.91, and Section O of this permit.

Carbon Dioxide Stream Analysis

WCS will analyze the carbon dioxide stream during the operation period to yield data representative of its chemical and physical characteristics and to meet the requirements of 40 C.F.R. § 146.90(a). Sampling will take place continuously via permanently installed field analysis equipment. WCS will sample and analyze the carbon dioxide stream as presented below.

Analytical Parameters

WCS will employ continuous monitoring of the carbon dioxide stream with in-situ analysis at the Wabash facility. Carbon dioxide will be separated and liquified by lowering the temperature of the fluid. The carbon dioxide will be sampled upstream of the main pump in the inlet pipe for the following parameters:

Table 1: CO₂ Stream Analytical Parameters

Parameter	Analytical Method(s)
Oxygen	Mass Spectrometer
Nitrogen	Mass Spectrometer
Carbon Monoxide	Mass Spectrometer
Oxides of Nitrogen	Mass Spectrometer
Total Hydrocarbons	Mass Spectrometer
Methane	Mass Spectrometer

Parameter	Analytical Method(s)
Hydrogen Sulfide	Mass Spectrometer
carbon dioxide Purity	Mass Spectrometer
Moisture	Hygrometer

If at any time this continuous monitoring reveals a substantive change from expected for the carbon dioxide stream, process troubleshooting will begin to determine the root cause of the carbon dioxide quality deviation. If carbon dioxide purity falls below 99.5%, causes will be investigated and AoR re-modeling will be initiated, if appropriate.

Continuous Recording of Operational Parameters

WCS will install and use continuous recording devices to monitor injection pressure, rate, and mass; the pressure on the annulus between the tubing and the long string casing; the annulus fluid volume added or produced; and the temperature of the carbon dioxide stream.

System Operation Monitoring

WCS will perform the activities identified in Table 9 to monitor operational parameters and verify internal mechanical integrity of the injection well. All monitoring will take place at the locations and frequencies shown in the table.

Table 2: Sampling devices, locations, and frequencies for continuous monitoring.

Parameter	Device(s)	Location	Min. Sampling Frequency	Min. Recording Frequency
Injection pressure at Wellhead	Pressure Transducer	Surface	1 Second	1 Second
Injection rate	Coriolis Flow Meter	Surface	1 Second	1 Second
Injection mass	Coriolis Flow Meter	Surface	1 Second	1 Second
Annular pressure	Pressure Transducer	At Surface and above packer interval	1 Second	1 Second
Annulus fluid level	Level Instrument	Surface	1 Second	1 Second
CO ₂ stream temperature	Temperature Transducer	Surface	1 Second	1 Second
Injection pressure at Formation	Pressure Transducer	Approximately 4500 feet bgs in the injection well	1 Second	1 Second
Temperature at Formation	DTS/Temperature Transducer	In formation	1 Second	1 Second

Notes:

- Sampling frequency refers to how often the monitoring device obtains data from the well for a particular parameter. For example, a recording device might sample a pressure transducer monitoring injection pressure once every two seconds and save this value in memory.
- Recording frequency refers to how often the sampled information gets recorded to digital format (such as a computer hard drive). For example, the data from the injection pressure transducer might be recorded to a hard drive once every minute.

System Monitoring details

Above-ground pressure and temperature instruments shall be calibrated over the full operational range at least annually using ANSI or other recognized standards. In lieu of removing the injection tubing, downhole gauges will demonstrate accuracy by using a second pressure gauge, with current certified calibration, that will be lowered into the well to the same depth as the permanent downhole gauge. Pressure transducers shall have a drift stability of less than 1 psi over the operational period of the instrument and an accuracy of ± 5 psi. Sampling rates will be at least once per second. Temperature sensors will be accurate to within one degree Celsius. Distributed Temperature Sensing (DTS) sampling rate will be once per 10 seconds.

Flow will be monitored with a Coriolis mass flowmeter at the outlet of the pumping facility. The flowmeter will be calibrated using accepted standards and be accurate to within ± 0.1 percent. The flowmeter will be calibrated for the entire expected range of flow rates.

Injection Rate and Pressure Monitoring

The Surface Facility Equipment and Control System will limit the bottomhole pressure to the MIP listed in Attachment A of this permit. NOTE: The injection pressure limit may be changed if the Fracture Gradient is significantly different during subsequent well testing during the drilling of the injection well(s). All injection operations will be continuously monitored and controlled by the Wabash Carbon Service (WCS) operations staff using the distributive process control system. This system will continuously monitor, control, record, and will alarm and shutdown if specified control parameters exceed their normal operating range. The initial alarm set points are as follows:

PARAMETER/CONDITION	LIMITATION	UNIT	Alarm	Warn
Maximum Injection Pressure - Surface	1296	psig	1270	1100
Maximum Injection Pressure - Injection Zone at 3970 feet bgs	2537	psig	2490	2350
Minimum Annulus Pressure	100	psig	105	110
Minimum Annulus Pressure/Tubing Differential (directly above and across packer)	100	psig	105	110
Carbon Dioxide Purity	>99.5	percent	99.6	99.7
Maximum Injection Rate	834,390	metric tons/year	830,000	826,047

These set points may need to be adjusted after the injection well is constructed and the startup testing has been conducted. The final alarm set points will be included in the startup report submitted to EPA.

More specifically, all critical system parameters, e.g., pressure, temperature, and flow rate will have continuous electronic monitoring with signals transmitted back to a master control system. WVR supervisors and operators will monitor the status of the entire system from the main operations control room.

Calculation of Injection Volumes

Flow rate is measured on a mass basis (lb/hr). The downhole pressure and temperature data will be used to perform the injectate density calculation.

The volume of carbon dioxide injected will be calculated from the mass flow rate obtained from the mass flow meter installed on the injection line. The mass flow rate will be divided by density and multiplied by injection time to determine the volume injected.

Density will be calculated using the correlation developed by Ouyang (2011). The correlation uses the temperature and pressure data collected to determine the carbon dioxide density. The density correlation is given by:

$$r = A_0 + A_1 * P + A_2 * P^2 + A_3 * P^3 + A_4 * P^4$$

Where r is the density, P is the pressure in psi, and A are coefficients determined by the equations:

$$A_i = b_{i0} + b_{i1} * T + b_{i2} * T^2 + b_{i3} * T^3 + b_{i4} * T^4$$

T is the temperature in degrees Celsius and the b coefficients are presented in Table 3 and Table 4 below.¹

Table 3: Injection Volume calculation b coefficients, pressure <3000 psi.

	b _{i0}	b _{i1}	b _{i2}	b _{i3}	b _{i4}
i=0	- 2.148322085348 E+05	1.168116599408 E+04	2.302236659392 E+02	1.967428940167 E+00	- 6.18484276414 5E-03
i=1	4.757146002428 E+02	- 2.619250287624 E+01	5.215134206837 E-01	- 4.494511089838 E-03	1.42305879598 2E-05
i=2	- 3.713900186613 E-01	2.072488876536 E-02	5.215134206837 E-01	3.622975674137 E-06	- 1.15505086032 9E-08
i=3	1.228907393482 E-04	6.930063746226 E-06	1.406317206628 E-07	- 1.230995287169 E-09	3.94841742804 0E-12
i=4	- 1.466408011784 E-08	8.338008651366 E-10	- 1.704242447194 E-11	1.500878861807 E-13	- 4.83882657417 3E-16

Table 4: Injection Volume calculation b coefficients, pressure >3000 psi.

	b _{i0}	b _{i1}	b _{i2}	b _{i3}	b _{i4}
i=0	6.897382693936E +02	2.730479206931E +00	- 2.25410236454 2E-02	- 4.65119614691 7E-03	3.43970223495 6E-05
i=1	2.213692462613E- 01	- 6.547268255814E- 03	5.98225888265 6E-05	2.27499741252 6E-06	- 1.88836133766 0E-08
i=2	- 5.118724890479E- 05	2.019697017603E- 06	- 2.31133209718 5E-08	4.07955740467 9E-10	3.89359964187 4E-12
i=3	5.517971126745E- 09	- 2.415814703211E- 10	3.12160348652 4E-12	3.17127108487 0E-14	3.56078555040 1E-16
i=4	- 2.184152941323E- 13	1.010703706059E- 14	- 1.40662068188 3E-16	- 8.95773113644 7E-19	1.21581046953 9E-20

The final volume basis will be calculated as follows:

¹ Ouyang 2011, "New Correlations for Predicting the Density and Viscosity of Supercritical Carbon Dioxide Under Conditions Expected in Carbon Capture and Sequestration Operations," The Open Petroleum Engineering Journal, 2011, 4, 13-21.

$$\text{Volume basis (m}^3\text{/hr)} = \text{Mass basis (kg/hr)} / \text{density (kg/m}^3\text{)}$$

Continuous Monitoring of Annular Pressure

WCS will use the procedures below to monitor annular pressure.

The following procedures will be used to limit the potential for any unpermitted fluid movement into or out of the annulus:

- 1) The annulus between the tubing and the long string of casing will be filled with brine. The brine will have a specific gravity and a density that meets the requirements of the downhole conditions. The final values will be determined after the construction of the injection wells.
- 2) The surface annulus pressure will be kept at a minimum of 100 pounds per square inch (psi) during injection (This is subject to changes based upon actual conditions encountered at the injection site).
- 3) During periods of well shut down, the surface annulus pressure will be kept at a minimum pressure to maintain a pressure differential of at least 100 psi between the annular fluid directly above (higher pressure) and below (lower pressure) the injection tubing packer set at ~ 4500' MD or in kelly bushing – KB or subsea depths (This is subject to change based on actual depths obtained during the drilling and completion of the wells and the packer setting depths will be reported after the wells are completed and prior to obtaining pre-injection authorization)
- 4) The pressure within the annular space, over the interval above the packer to the confining layer, will be greater than the pressure of the injection zone formation at all times.
- 5) The pressure in the annular space directly above the packer will be maintained at least 100 psi higher than the adjacent tubing pressure during injection.

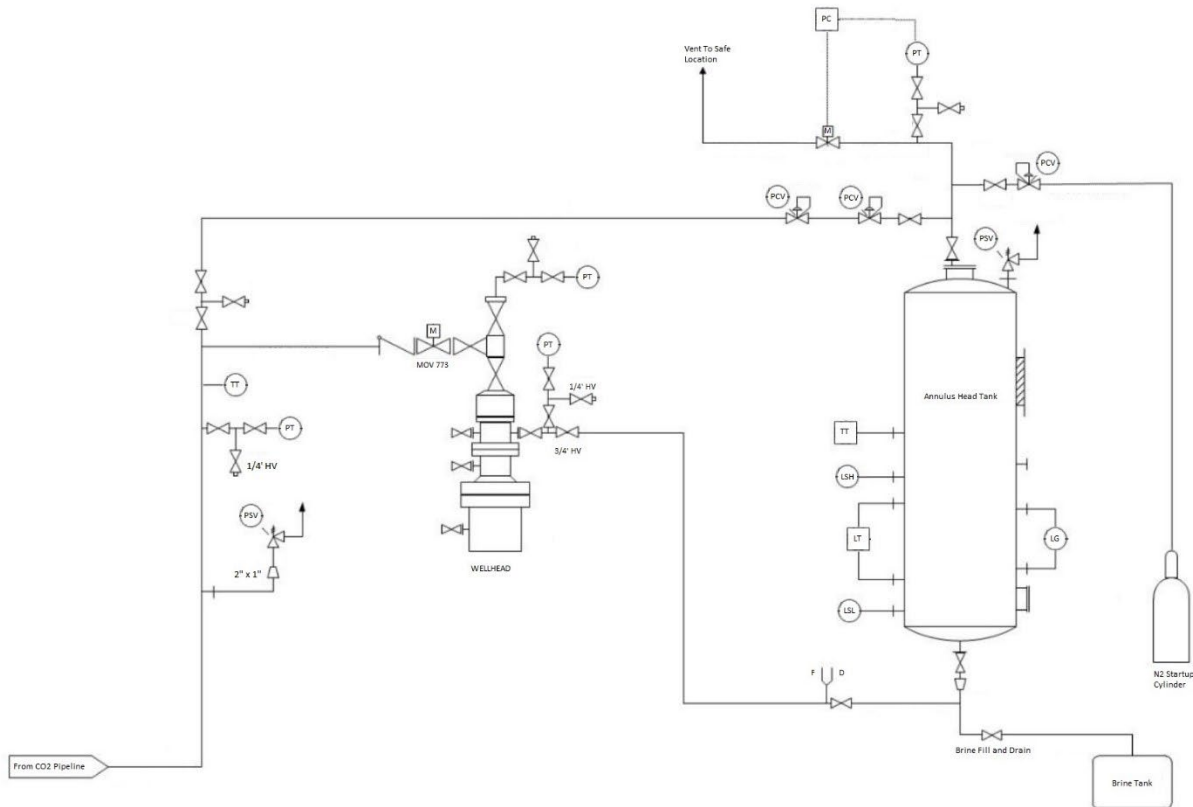
Figure 1: Process instrument diagram for the injection well annulus protection system.

The annular monitoring system consists of a continuous annular pressure gauge, a pressurized annulus fluid reservoir (annulus head tank), pressure regulators, and tank fluid level indication. The annulus system will maintain annulus pressure by controlling the pressure on the annulus head tank using either compressed nitrogen or carbon dioxide.

The annulus pressure will be maintained between approximately 425-525 (subject to change – will finalize after completion) psi and monitored by the WVR control system gauges. The annulus head tank pressure will be controlled by pressure regulators, one set of regulators to maintain pressure above 400 psi by adding compressed nitrogen or carbon dioxide and the other to relieve pressure above 525 psi by venting gas off the annulus head tank.

Any changes to the composition of annular fluid must be approved by the Director and will be reported in the next report submitted to EPA.

If system communication is lost for greater than 30 minutes, project personnel will perform field monitoring of manual gauges every four hours or twice per shift for both wellhead surface injection pressure and annulus pressure and record hard copies of the data until communication is restored.

Average annular pressure and annulus tank fluid level will be recorded daily. The volume of fluid added or removed from the system will be recorded.

Casing-Tubing Pressure Monitoring

WCS will monitor the casing-tubing pressure on a continuous basis. During the injection timeframe of the project, the casing-tubing pressure will be monitored and recorded in real time. Surface pressure of the casing-tubing annulus is anticipated to be from 425 to 525 psi. As detailed in the Emergency and Remedial Response Plan, significant changes in the casing-tubing annular pressure will be investigated.

Corrosion Monitoring

To meet the requirements of 40 C.F.R. § 146.90(c) and Section N(6) of this permit, WCS must monitor well materials during the operational period for loss of mass, thickness, cracking, pitting, and other signs of corrosion to ensure that the well components meet the minimum standards for material strength and performance.

Monitoring location and frequency

This monitoring will occur quarterly, in accordance with Section O and Attachment A of this permit.

WCS will monitor corrosion using Corrosion Coupon Method and collect samples according to the description below.

Sample description

Samples of material used in the construction of the compression equipment, pipeline and injection well which come into contact with the carbon dioxide stream will be included in the corrosion monitoring program either by using actual material and/or conventional corrosion coupons. The samples consist of those items listed in Table 5 below. Each coupon will be weighed, measured, and photographed prior to initial exposure (see “Sample Handling and Monitoring”) below

Table 5: List of equipment coupon with material of construction.

Equipment Coupon	Material of Construction
Pipeline	Carbon Steel
Long String Casing (Surface – 3,200 ft)	Carbon Steel
Long String Casing (3,200 ft – TD)	Chrome Alloy
Injection Tubing	Chrome Alloy
Wellhead	Chrome Alloy
Packers	Chrome Alloy

Monitoring details

Each sample will be attached to an individual holder and then inserted in a flow through pipe arrangement (see Figure 2). The corrosion monitoring system will be located downstream of all process

compression/dehydration/pumping equipment (i.e., at the beginning of the pipeline to the wellhead). To accomplish this, a parallel stream of high-pressure carbon dioxide will be routed from the pipeline through the corrosion monitoring system and then back into a lower pressure point upstream in the pumping system. This loop will operate any time injection is occurring. No other equipment will act on the carbon dioxide past this point; therefore, this location will provide representative exposure of the samples to the carbon dioxide composition, temperature, and pressures that will be seen at the wellhead and injection tubing. The holders and location of the system will be included in the pipeline design and will allow for continuation of injection during sample removal.

Figure 2: Corrosion Coupon Monitoring System



Sample Handling and Monitoring

The coupons will be handled and assessed for corrosion using the American Society for Testing and Materials (ASTM) G1-03, Standard Practice for Preparing, Cleaning, and Evaluating Corrosion Test Specimens (ASTM 2011). The coupons will be photographed, visually inspected with a minimum of 10x power, dimensionally measured (to within 0.0001 inch), and weighed (to within 0.0001 gm).

Above Confining Zone Groundwater Monitoring

WCS will monitor groundwater quality and geochemical changes above the confining zone during the operation period to meet the requirements of 40 C.F.R. § 146.90(d) and Section N(4) of this permit.

Monitoring location and frequency

Table 6 shows the planned monitoring methods, locations, and frequencies for groundwater quality and geochemical monitoring above the confining zone.

Table 6: Monitoring of groundwater quality and geochemical changes above the confining zone.

Target Formation	Monitoring Activity	Monitoring Location(s)	Spatial Coverage	Frequency
Pennsylvanian Strata	Fluid Sampling	GM1-GM10	10 wells at expected depth of <100 ft	Year 1-2 Quarterly Year 3-12 Semi-Annual
Silurian	Fluid Sampling	CM1, CM2	1 sample point @2,000 ft	Annual
	Pulse Neutron Logging		Well Bore	

*Analytical parameters***Table 7: Summary of analytical and field parameters for groundwater samples.**

Parameters	Analytical Methods
Formation: Pennsylvanian	
Cations: Al, Ba, Mn, As, Cd, Cr, Cu, Pb, Sb, Se, and Tl	ICP-MS EPA Method 6020
Cations: Ca, Fe, K, Mg, Na, and Si	ICP-AES EPA Method 6010B
Anions: Br, Cl, F, NO ₃ , and SO ₄	Ion Chromatography EPA Method 300.0
Dissolved carbon dioxide	Gas Chromatographic EPA Method RSK 175
Total Dissolved Solids	Gravimetry SM: 2540C
Alkalinity	Alkalinity by Titration SM:2320 B
pH (field)	Electrometric EPA-NERL: 150.1
Specific conductance (field)	4 AC electrode EPA-NERL: 120.1
Temperature (field)	Thermistor EPA-NERL: 170.1
Formation: Silurian	
Cations: Al, Ba, Mn, As, Cd, Cr, Cu, Pb, Sb, Se, and Tl	ICP-MS EPA Method 6020
Cations: Ca, Fe, K, Mg, Na, and Si	ICP-OES EPA Method 6010B

Parameters	Analytical Methods
Anions: Br, Cl, F, NO ₃ , and SO ₄	Ion Chromatography EPA Method 300.0
Dissolved carbon dioxide	Gas Chromatographic EPA Method RSK 175
Isotopes: $\delta^{13}\text{C}$ of DIC	Isotope ratio mass spectrometry
Total Dissolved Solids	Gravimetry SM:2540C
Water Density (field)	Oscillating body method SM 2710
Alkalinity	Alkalinity by Titration SM: 2320B
pH (field)	Glass electrode EPA-NERL: 150.1
Specific conductance (field)	4 AC electrode EPA-NERL: 120.1
Temperature (field)	Thermistor EPA-NERL: 170.1

Sampling methods

Sampling will be performed as described in Section B.2 of the QASP; this section of the QASP describes the groundwater sampling methods to be employed, including sampling SOPs (Section B.2.a/b), and sample preservation (Section B.2.g).

Sample handling and custody will be performed as described in Section B.3 of the QASP.

Quality control will be ensured using the methods described in Section B.5 of the QASP.

Laboratory to be used/chain of custody procedures

Final laboratory selection has not been made at this time. The laboratory selected will meet all requirements set forth in the Testing and Monitoring Plan and the QASP. The Chain-of-Custody procedures will follow the requirements of section B.3.e of the QASP.

Section A.4 Quality Objectives and Criteria of the QASP provides the detection limits and analytical methods to be employed during the Testing and Monitoring of all critical parameters of the project.

External Mechanical Integrity Testing

WCS will conduct at least one of the tests presented in Table 8 during the injection and post-injection phase to verify external MI as required at §§ 146.89(c) and 146.90 and Sections L and N(6) of this permit.

Table 8: Mechanical Integrity Tests.

Test Description	Location	Frequency
Temperature Log	WVCCS1, WVCCS2, FM1, FM2	Annual
Digital Temperature System	WVCCS1 & WVCCS2	Continuous
Oxygen Activation Log	WVCCS1 & WVCCS2	Annual

Test Procedures

The following testing procedures are preliminary examples of the testing protocols expected to be used by WCS. The following procedures are approved by use by the Director per Section L of this permit. Any deviation from the methods and procedures below will require approval by the Director at least 30 day prior to conducting the test and must comply with the witnessing requirements of Section L(1) of this permit.

Temperature Logging Using Wireline

To ensure the mechanical integrity of the casing of the injection well, temperature data will be recorded across the wellbore from surface down to primary caprock. Bottom hole pressure data near the packer will also be provided. The following procedures will be employed for temperature logging. The well should not be in a state of injection for at least 36 hours prior to commencing operations in order to allow for stabilization.

- 1) To conduct a static temperature log, the well must be shut in for at least 36 hours, or longer if temperature stabilization based on previous logs requires more time.
- 2) If the well cannot be shut in for 36 hours, shut in for as long as possible and run two logs at least six hours apart.
- 3) Calibrate the temperature tool in a bucket of ambient temperature water and a bucket of ice water immediately prior to conducting the test.
- 4) Log from the top of the well to the bottom, recording both temperature and natural gamma ray activity.
- 5) Record log data at least once per foot.
- 6) Logging speed shall not exceed 30 feet per minute. Reduce speed to 20 feet per minute in air-filled well bores.
- 7) The test shall include a written report by a knowledgeable log analyst. Such report must explain any anomalies shown in the results.

- 8) The test report shall include an up-to-date well schematic, digital logging data on CD/flash drive/email in a spreadsheet format, and a plot of the logging activity.
- 9) The test report shall include a tabulation of values for the following background parameters: EPA permit number, long string casing length (ft), tubing and/or tail pipe lowermost depth (ft), top of open hole or uppermost perforation (ft), well total depth (ft), plugged back total depth or top of fill depth (ft), Kelly bushing elevation (ft), depth to top of confining zone (ft), and depth to top of permitted injection zone (ft). The test report shall also include a tabulation of values for the following test specific parameters: test date, depth reference (Kelly bushing or ground level), date of last injection, temperature of last injected fluid (F), elapsed time since last injection (hr), volume injected into the well in the past year (gal), names and depths of any other injection formations used at the site, temperatures logged by the tool and thermometer during calibration (F), depth to fluid level in the tubing (ft), depth to top of receptive strata (ft), and depth to bottom of receptive strata (ft).
- 10) The test must conclusively demonstrate its objectives and satisfy the Director to be considered a completed test.

Temperature Logging Using DTS Fiber Optic Line

The injection wells (WVCCS1 & WVCCS2) will be equipped with a DTS fiber optic temperature monitoring system that is capable of monitoring the injection well's annular temperature along the length of the tubing string. The DTS line is used for real time temperature monitoring and, like a conventional temperature log, can be used for early detection of temperature changes that may indicate a loss of well mechanical integrity. The procedure for using the DTS for well mechanical integrity is as follows:

- 1) After the well is completed and prior to injection, a baseline temperature profile will be established. This profile represents the natural temperature gradient for each stratigraphic zone.
- 2) During injection operation, record the temperature profile for 6 hours prior to shutting in well.
- 3) Stop injection and record temperature profile for 6 hours.
- 4) Evaluate data to determine if additional cooling time is needed for interpretation.
- 5) Start injection and record temperature profile for 6 hours.
- 6) Data interpretation involves comparing the time lapse well temperature profiles and looking for temperature anomalies that may indicate a failure of well integrity, i.e., tubing leak or movement of fluid behind the casing. The DTS system monitors and records the well's temperature profiles at a pre-set frequency in real time. As the well cools down the temperature profile along the length of the tubing string is compared to the baseline. Any unplanned fluid movement into the annulus or outside the casing creates a temperature anomaly when compared to the baseline cooling profile. This data can be continuously monitored to provide real time MIT surveillance making this technology superior to wireline temperature logging.

Oxygen Activation (OA) Logging

To ensure the mechanical integrity of the casing of the injection well, logging data will be recorded

across the wellbore from surface down to the base of the casing. Bottom hole pressure data near the packer will also be provided. OA logging will be carried out while injection is occurring. The following procedures will be employed:

- 1) Move in and rig up an electrical logging unit with lubricator.
- 2) Conduct a baseline Gamma Ray Log and casing collar locator log from the top of the injection zone to the surface prior to taking the stationary readings with the OA tool.
- 3) The OA log shall be used only for casing diameters of greater than 1-11/16 inches and less than 13-3/8 inches.
- 4) All stationary readings should be taken with the well injecting fluid at the normal rate with minimal rate and pressure fluctuations.
- 5) Prior to taking the stationary readings, the OA tool must be properly calibrated in a “no vertical flow behind the casing” section of the well to ensure accurate, repeatable tool response and for measuring background counts.
- 6) Take, at a minimum, a 15-minute stationary reading adjacent to the confining interval located immediately above the injection interval. This must be at least 10 feet above the injection interval so that turbulence does not affect the readings.
- 7) Take, at a minimum, a 15-minute stationary reading at a location approximately midway between the base of the lowermost USDW and the confining interval located immediately above the injection interval.
- 8) Take, at a minimum, a 15-minute stationary reading adjacent to the top of the confining zone.
- 9) Take, at a minimum, a 15-minute stationary reading at the base of the lowermost USDW.
- 10) If flow is indicated by the OA log at a location, move uphole or downhole as necessary at no more than 50-foot intervals and take stationary readings to determine the area of fluid migration.
- 11) Interpret the data: Identification of differences in the activated water’s measured gamma ray count-rate profile versus the expected count-rate profile for a static environment. Differences between the measured and expected may indicate flow in the annulus or behind the casing. The flow velocity is determined by measuring the time that the activated water passes a detector.

NOTE: WCS will run one or more of the listed logging tests to verify external mechanical integrity and confirm that there is no upward flow behind casing above the injection zone. However, it is not anticipated that all the logs be run to confirm external mechanical integrity.

The range, precision, and QC requirements of the different gauges used for MIT testing are presented in section A.4.a and A.4.g of the QASP.

Pressure Fall-Off Testing

WCS will perform pressure fall-off tests during the injection phase as described below to meet the requirements of 40 C.F.R. § 146.90(f) and with Section L(8) of this permit. Pressure fall-off testing will be performed during system operation every 5 years and at the end of system operation.

Pressure Fall-off Test Procedure

- 1) Injection of normal injectate at the normal rate is preferred.
- 2) The injection period should be at least 50% longer than the planned shut-in time, or at minimum as long as operationally possible. During this time injection at a constant rate (+/- 10%) should be attempted.
- 3) The pressure gauge utilized for the pressure transient test shall have been calibrated no more than one year prior to the test date.
- 4) Place the pressure gauge downhole at approximately the top of the permitted injection zone at least one hour prior to ceasing injection.
- 5) Following at least one hour of pressure data collection during injection, shut-in the well as quickly as possible.
- 6) Collect data at a frequency of at least one data point every 10 seconds for at least the first five minutes after shut-in; between five and 30 minutes at no less than one reading every 30 seconds; and the operator can reduce frequency as required after 30 minutes.
- 7) End pressure measurements when pressure is relatively stable, when operational necessity dictates, when sufficient radial flow dominated data has been collected to allow evaluation of kh and extrapolation of pressure to infinite shut-in time is possible, or if boundary effects are observed.
- 8) The test shall include a written report by a knowledgeable well test analyst. Such report must explain any anomalies shown in the results.
- 9) The test report shall include an up-to-date well schematic, a copy of the dated calibration certificate for the gauge utilized, and digital pressure data on CD/flash drive/email in a spreadsheet format.
- 10) The test report shall include a tabulation of values for the following background parameters: EPA permit number, porosity, net thickness (ft), viscosity (cp), formation compressibility (per psi), long string casing inner diameter (in), open hole diameter (in), and Kelly bushing elevation (ft). The test report shall also include a tabulation of values for the following test specific parameters: test start date/time, test end date/time, test length (hr), depth reference (Kelly bushing or ground level), specific gravity of test fluid, test fluid compressibility (per psi), gauge depth (ft), gauge calibration date, pressure required to maintain tubing fluid to the surface (psi), final tubing fluid level (ft), final flow rate immediately prior to shut-in (gpm), cumulative volume injected since last pressure equalization (gal), permeability- thickness (md-ft), skin factor, radius of investigation (ft), final measured flowing pressure (psi), final measured shut-in pressure (psi), and p* pressure (psi). Pressure gauge units (psia or psig) shall be specified.
- 11) The test must conclusively demonstrate its objectives and satisfy the Director to be considered a completed test.

Carbon Dioxide Plume and Pressure Front Tracking

WCS will employ direct and indirect methods to track the extent of the carbon dioxide plume and the presence or absence of elevated pressure during the operation period to meet the requirements of 40 C.F.R. § 146.90(g) and Section N(5) of this permit. The primary location for in-formation tracking of the carbon dioxide plume and pressure front will be FM1 & FM2. FM1 will have an offset of 1.95 miles from WVCCS1 and FM2 will have an offset of 1.75 miles from WVCCS2. FM1 & FM2 have been located to account for the physical characteristics of the subsurface (dip). The placement of FM1 and

FM2 places them on the upslope of the dip, to properly monitor the advancement of the carbon dioxide plume and pressure front to the predicted furthest distance from the injection well. Periodic fluid samples will be analyzed for the presence of carbon dioxide to further refine plume tracking. Based on the prediction from the AoR modeling the carbon dioxide plume is expected to reach the formation monitoring wells at year 12 of injection, the final year.

Plume monitoring location and frequency

Table 9 presents the methods that WCS will use to monitor the position of the carbon dioxide plume, including the activities, locations, and frequencies WCS will employ. The parameters to be analyzed as part of fluid sampling in the injection zone and associated analytical methods are presented in Table 10.

WCS will conduct fluid sampling and analysis to detect changes in formation fluids in order to directly monitor the carbon dioxide plume. The parameters to be analyzed as part of fluid sampling in the Potosi dolomite (i.e., the injection zone) and analytical methods are presented in Table 8. WCS will deploy pressure/temperature monitors and DTS to directly monitor the position of the pressure front. Indirect plume monitoring will be employed using pulsed neutron capture/RST logs to monitor carbon dioxide saturation. 3D seismic profiles will be used to image the developing carbon dioxide plume for indirect plume monitoring.

Plume monitoring details

For information concerning the type and specification of gauges used for the continuous monitoring of the Plume please see QASP Table 12.

Table 9: Plume monitoring activities

Target Formation	Monitoring Activity	Monitoring Location(s)	Spatial Coverage	Frequency
DIRECT PLUME MONITORING				
Potosi	Fluid Sampling	FM1 & FM2	1 point location @4,500 Ft MD (4,000 Ft Total Vertical Depth subsea (TVDss))	Annual
	Pressure Monitoring	FM1 & FM2	1 point location @4,500 Ft MD (4,000 Ft TDVss)	Continuous
	Temperature Monitoring	FM1 & FM2	1 point location @4,500 Ft MD (4,000 Ft TDVss)	Continuous

Target Formation	Monitoring Activity	Monitoring Location(s)	Spatial Coverage	Frequency
INDIRECT PLUME MONITORING				
Potosi	Pulse Neutron Logging/RST	FM1 & FM2	Well Bore	Annual
	3D surface seismic survey	Surface	Variable based on time	5 year

Table 10: Summary of analytical and field parameters for fluid sampling in the injection zone.

Parameters	Analytical Methods
Potosi	
Cations: Al, Ba, Mn, As, Cd, Cr, Cu, Pb, Sb, Se, and Tl	ICP-MS EPA Method 6020
Cations: Ca, Fe, K, Mg, Na, and Si	ICP-OES EPA Method 6010B
Anions: Br, Cl, F, NO ₃ , and SO ₄	Ion Chromatography EPA Method 300.0
Dissolved CO ₂	Gas Chromatographic EPA Method RSK 175
Isotopes: $\delta^{13}\text{C}$ of DIC	Isotope ratio mass spectrometry
Total Dissolved Solids	Gravimetry SM:2540C
Water Density (field)	Oscillating body method SM 2710
Alkalinity	Alkalinity by Titration SM: 2320B
pH (field)	Glass electrode EPA-NERL: 150.1
Specific conductance (field)	4 AC electrode EPA-NERL: 120.1
Temperature (field)	Thermistor EPA-NERL: 170.1

Pressure-front monitoring location and frequency

Table 18 presents the methods that WCS will use to monitor the position of the pressure front, including the activities, locations, and frequencies WCS will employ.

Quality assurance procedures for these methods are presented in B.5 of the QASP.

Pressure-front monitoring details

Pressure-front monitoring will occur via continuous monitoring of conditions in the Potosi dolomite (injection zone) at FM1 & FM2.

For information concerning the type and specification of gauges used for the continuous monitoring of the pressure front please see QASP Table 12.

Baseline data will be collected from FM1 & FM2 before the start of injection activities. This baseline data will be used to generate comparative data between the baseline case of the predictive model and expected rate of change in the formation conditions. As measured pressures and temperatures change the data will be compared to the predicted data from the model. As appropriate, re-evaluation of the model, or further investigation of the downhole conditions will be performed to ensure that no major deviation from the expected behavior of the pressure front is experienced.

Table 11: Pressure-front monitoring activities.

Target Formation	Monitoring Activity	Monitoring Location(s)	Spatial Coverage	Frequency
DIRECT PRESSURE-FRONT MONITORING				
Potosi	Pressure Monitoring	FM1 & FM2	1 point location @4,500 Ft MD (4,000 Ft TDVss)	Continuous
	Temperature Monitoring	FM1 & FM2	1 point location @4,500 Ft MD (4,000 Ft TDVss)	Continuous

The Quality Assurance and Surveillance Plan (QASP) is available in the Administrative Record for this permit.

ATTACHMENT D: WELL PLUGGING PLANS**Facility Information**

Facility name: Wabash Carbon Services
WVCCS1 and WVCCS2

Facility address: 444 W. Sandford Ave, West Terre Haute, IN 47885

Well location: WVCCS1 Clinton, Vermillion County, Indiana
39 37' 27.88" N, 87 29 19.17" W
(Decimal Degrees X, Y: -87.48866, 39.62441)
WVCCS2 West Terre Haute, Vigo County, Indiana
39 33' 3.72" N, 87 29' 16.60" W
(Decimal Degrees X,Y: -87.48794, 39.55103)

Wabash Carbon Services (WCS) will conduct injection well plugging and abandonment according to the procedures below and in accordance with 40 C.F.R. § 146.92 and Section P of this permit.

Planned Tests or Measures to Determine Bottom-Hole Reservoir Pressure

Bottom-hole pressure measurements will be used to determine the pressure required to squeeze the cement from the well casing into the injection reservoir. In addition, these data will be used to determine the need for well control equipment. The weight of brine required to prevent the well from flowing (under balanced) will be calculated using this information. The pressure measurements will also be used to determine the formulation of cement to be used to plug the well.

During injection well operation there will be in-formation pressure devices continuously monitoring the reservoir pressure. After cessation of injection activities these gauges will be used to obtain the final measurements of pressure in the injection zone. In the event that the originally installed gauges are not functioning properly after cessation of injection, bottom hole injection zone pressure and temperature will be obtained by running gauges in hole via wireline.

Table 1: Planned MITs.

Test Description	Location
Cement Bond Log (CBL)	Well Casing
Ultrasonic Imaging Tool (USIT)	Well Casing
Temperature Log	Well Casing
Oxygen Activation Log	Well Casing

Table 27: Plugging details.

Plug Information	Plug #1	Plug #2	Plug #3	Plug #4	Plug #5	Plug #6	Plug #7	Plug #8	Plug #9
Outer Diameter of casing in which plug will be placed (in.) (Capacity of 9 5/8" 24# N-80 is 0.393 cubic feet/ft or 0.070bbl/ft)	9 5/8	9 5/8	9 5/8	9 5/8	9 5/8	9 5/8	9 5/8	9 5/8	9 5/8
Depth to bottom of tubing or drill pipe (ft)	0	1422	1922	2422	2922	3422	3922	4422	4922
Sacks of cement to be used (each plug)	365	128	128	166	166	166	166	166	133
Slurry volume to be pumped (ft ³)	558	196	196	196	196	196	196	196	157
Slurry weight (lb./gal)	12.77	12.77	12.77	15.6	15.6	15.6	15.6	15.6	15.6
Calculated top of plug (ft)	3900	3400	2900	2400	1900	1400	900	400	0
Bottom of plug (ft)	~5,322	3900	3,400	2900	2400	1900	1400	900	400
Type of cement or other material	EverCRETE/Yield 1.53/cubic feet/sx			Class G/Yield 1.18 cubic feet/sx					
Method of emplacement (e.g., balance method, retainer method, or two-plug method)	Retainer	Balanced		Balanced					

Figure 1: Injection Well Plugging Diagram

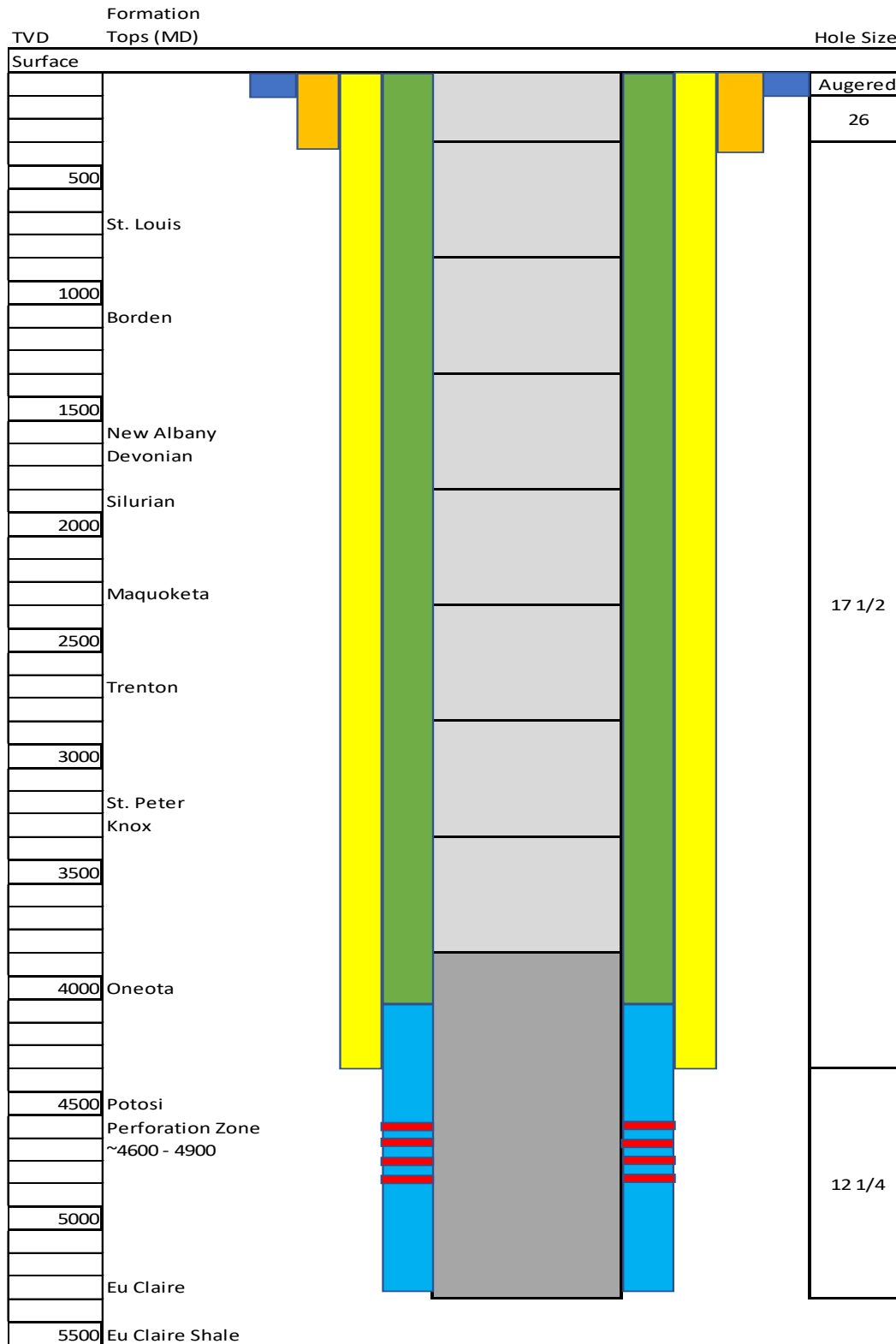

Figure 2: Confining Zone Monitoring Well Plugging Diagram

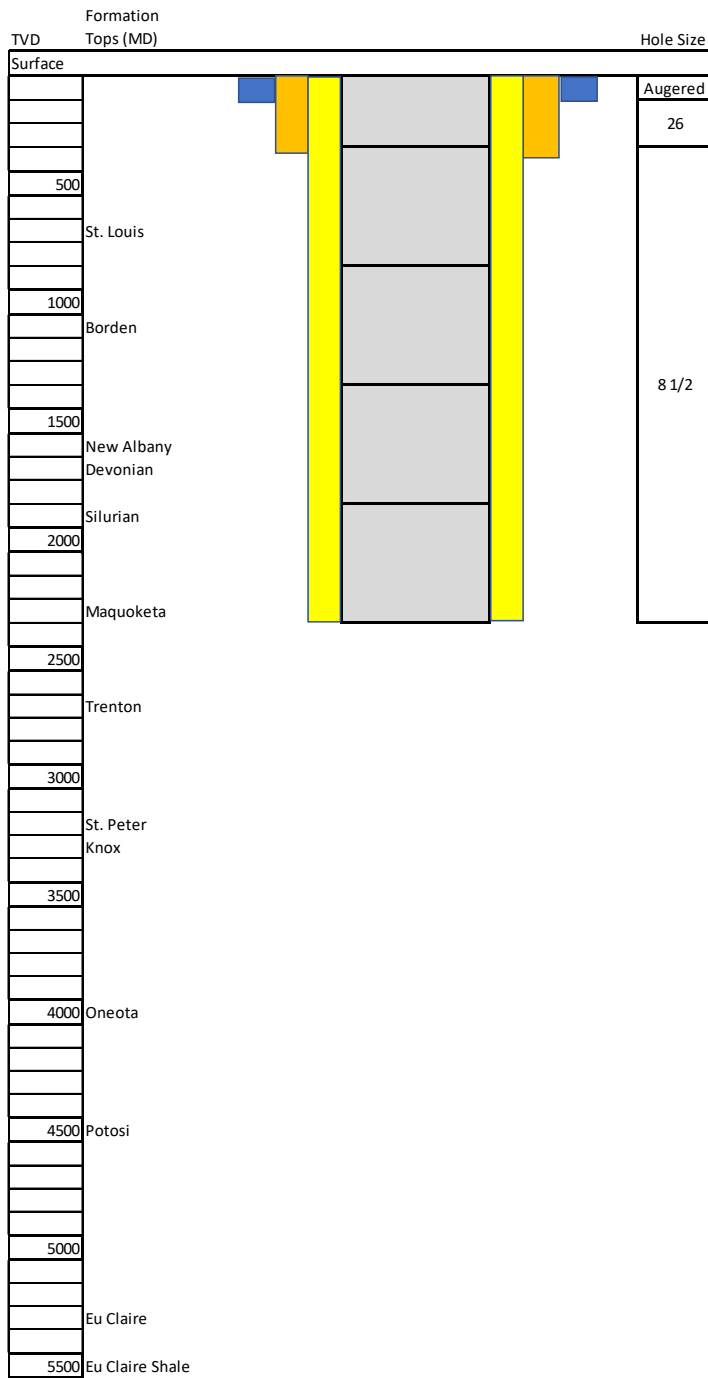

Figure 3: Injection Zone Monitoring Well Plugging Diagram

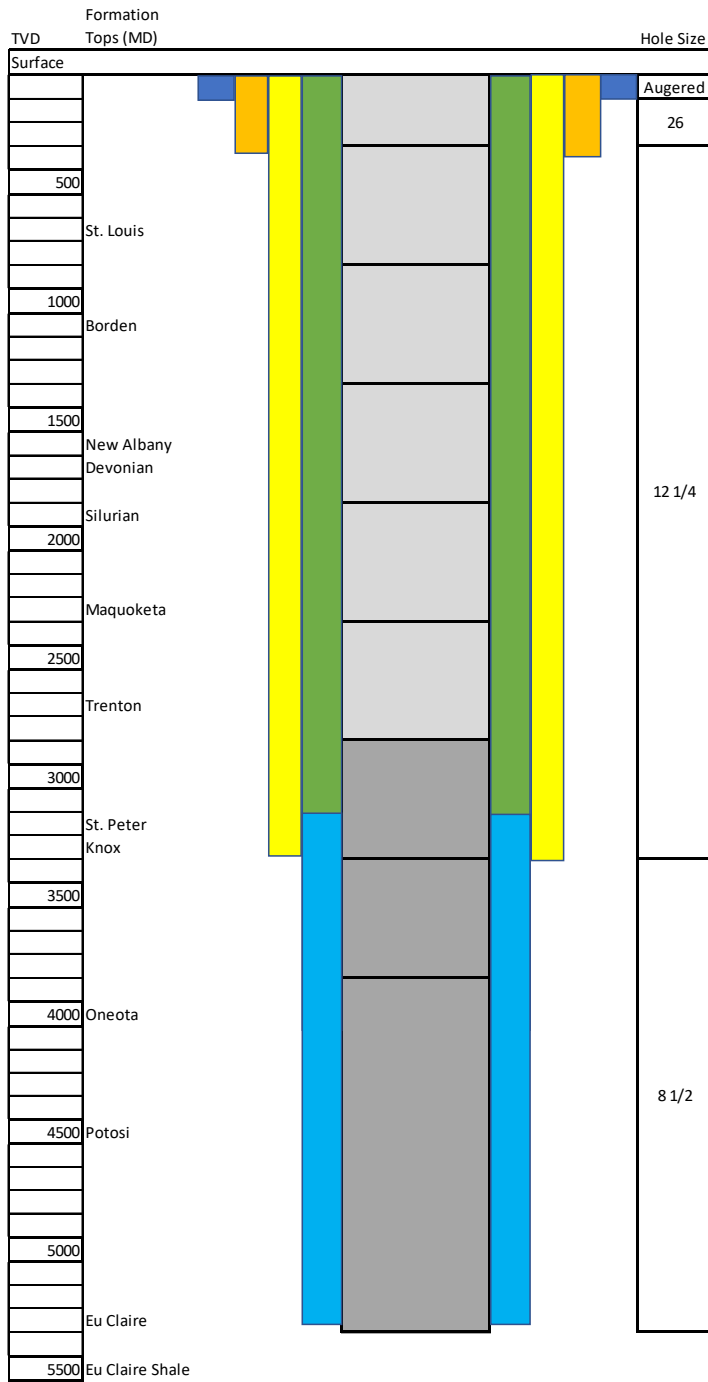
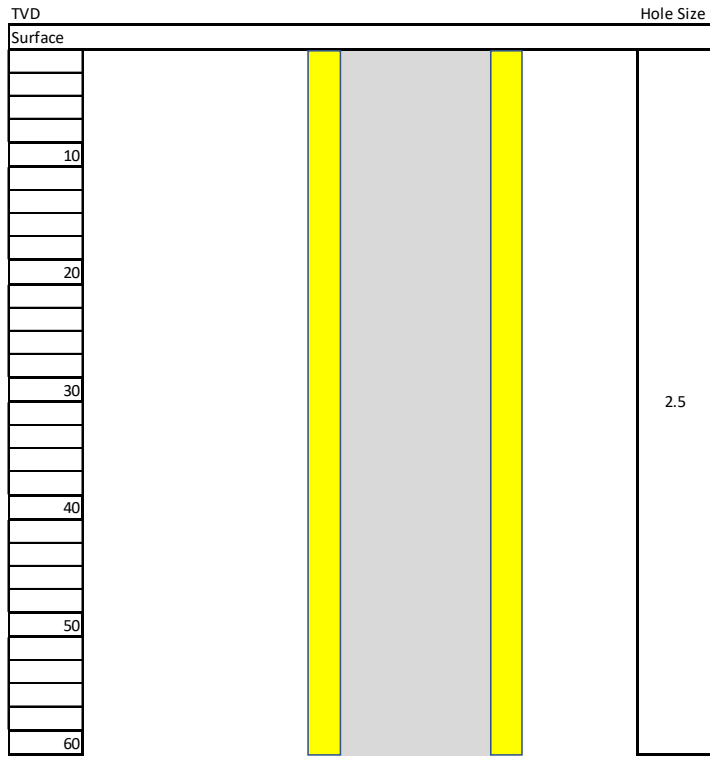

Figure 4: Groundwater Monitoring Well Plugging Diagram (typical)



ATTACHMENT E: POST-INJECTION SITE CARE AND SITE CLOSURE PLAN

Facility Information

Facility name: Wabash Carbon Services
WVCCS1 and WVCCS2

Facility address: 444 W. Sandford Ave, West Terre Haute, IN 47885

Well location: WVCCS1 Clinton, Vermillion County, Indiana
39 37' 27.88" N, 87 29 19.17" W
(Decimal Degrees X, Y: -87.48866, 39.62441)
WVCCS2 West Terre Haute, Vigo County, Indiana
39 33' 3.72" N, 87 29' 16.60" W
(Decimal Degrees X,Y: -87.48794, 39.55103)

The Post-Injection Site Care (PISC) and Site Closure period of this permit is 10 years after cessation of injection and system operation. The PISC and Site Closure plan describes the activities that Wabash Carbon Services (WCS) will perform to meet the requirements of 40 C.F.R. § 146.93 and Section P of this permit. WCS will monitor groundwater quality and track the position of the carbon dioxide plume and pressure front for the duration of the 10-year PISC period. WCS may not cease post-injection monitoring until a demonstration of non-endangerment of USDWs has been approved by the Director pursuant to 40 C.F.R. § 146.93(b)(3). Following approval for site closure, WSC will plug all monitoring wells, restore the site to its original condition, and submit a site closure report and associated documentation.

Post-Injection Monitoring Plan

Performing groundwater monitoring, USDW monitoring, injection formation pressure and temperature monitoring, and 2D/3D seismic monitoring as described in the following sections during the post-injection phase. The results of all post-injection phase testing and monitoring will be submitted annually by January 31st.

For the PISC plan the following definitions apply for the frequencies given for the different testing protocols described.

- 1) Continuous: Data is continuously sampled and recorded per the frequencies presented in Table 2 of this attachment.
- 2) Quarterly: Sampling will take place within 5 days before the following dates each year: March 31st, June 30th, September 30th, December 31st.
- 3) Semi-annual: Sampling will take place within 5 days before June 30th and December 31st.
- 4) Annual: Sampling will take place within 45 days before January 1st of each year.
- 5) 5 Year: Sampling will take place every 5 years within 45 days before January 1st during injection and PISC period.

Monitoring Above the Confining Zone

Table 1 presents the monitoring methods, locations, and frequencies for monitoring above the confining zone. Table 2 identifies the parameters to be monitored and the analytical methods WCS will employ.

Table 1: Monitoring of groundwater quality and geochemical changes above the confining zone.

Target Formation	Monitoring Activity	Monitoring Location(s)	Spatial Coverage	Frequency
Pennsylvanian Strata	Fluid Sampling	GM1, GM2...GM10	10 wells at expected depth of 100 Feet	Semi Annual
Silurian	Fluid Sampling	CM1, CM2	1 Sample Point @2,000 ft	Annual
	Pulse Neutron Logging		Well bore	

Table 2: Summary of analytical and field parameters for groundwater samples.

Parameters	Analytical Methods
Formation: Pennsylvanian	
Cations: Al, Ba, Mn, As, Cd, Cr, Cu, Pb, Sb, Se, and Tl	ICP-MS EPA Method 6020
Cations: Ca, Fe, K, Mg, Na, and Si	ICP-OES EPA Method 6010B
Anions: Br, Cl, F, NO ₃ , and SO ₄	Ion Chromatography, EPA Method 300.0
Dissolved carbon dioxide	Gas Chromatographic EPA Method RSK 175
Total Dissolved Solids	Gravimetry: SM 2540C
Alkalinity	Alkalinity by Titration SM:2320 B
pH (field)	Electrometric EPA-NERL: 150.1
Specific conductance (field)	4 AC electrode EPA-NERL: 120.1
Temperature (field)	Thermistor EPA-NERL: 170.1
Formation: Silurian	
Cations: Al, Ba, Mn, As, Cd, Cr, Cu, Pb, Sb, Se, and Tl	ICP-MS EPA Method 6020
Cations: Ca, Fe, K, Mg, Na, and Si	ICP-OES EPA Method 6010B
Anions: Br, Cl, F, NO ₃ , and SO ₄	Ion Chromatography, EPA Method 300.0

Parameters	Analytical Methods
Dissolved carbon dioxide	Gas Chromatographic EPA Method RSK 175
Isotopes: $\delta^{13}\text{C}$ of DIC	Isotope ratio mass spectrometry
Total Dissolved Solids	Gravimetry: SM 2540C
Water Density (field)	Oscillating body method ASTM D1217
Alkalinity	Alkalinity by Titration SM:2320 B
pH (field)	Electrometric EPA-NERL: 150.1
Specific conductance (field)	4 AC electrode EPA-NERL: 120.1
Temperature (field)	Thermistor EPA-NERL: 170.1

Table 3: Sampling and recording frequencies for continuous monitoring.

Parameter	Device(s)	Location	Min. Sampling Frequency	Min. Recording Frequency
Pressure/Temperature	Gauge	Silurian (CM1 & CM2)	1 Second	1 Second
Pressure/Temperature	Gauge	Potosi (FM1 & FM2)	1 Second	1 Second

Notes:

- Sampling frequency refers to how often the monitoring device obtains data from the well for a particular parameter. For example, a recording device might sample a pressure transducer monitoring injection pressure once every two seconds and save this value in memory.
- Recording frequency refers to how often the sampled information gets recorded to digital format (such as a computer hard drive). For example, the data from the injection pressure transducer might be recorded to a hard drive once every minute.

Table 4: Post-injection phase plume monitoring.

Target Formation	Monitoring Activity	Monitoring Location(s)	Spatial Coverage	Frequency
DIRECT PLUME MONITORING				
Potosi	Fluid Sampling	FM1 & FM2	1 point location @4,500 Ft MD (4,000 Ft TVDss)	Annual
	Pressure/Temperature Monitoring			Continuous

Target Formation	Monitoring Activity	Monitoring Location(s)	Spatial Coverage	Frequency
INDIRECT PLUME MONITORING				
Potosi	Pulse Neutron Logging/RST	FM1 & FM2	Well Bore	Annual
	3D surface seismic survey	Predicted Plume Radius	~16 Square miles per injection well	5 Year recurring

Table 5: Summary of analytical and field parameters for fluid sampling in the Potosi.

Parameters	Analytical Methods
Potosi	
Cations: Al, Ba, Mn, As, Cd, Cr, Cu, Pb, Sb, Se, and Tl	ICP-MS EPA Method 6020
Cations: Ca, Fe, K, Mg, Na, and Si	ICP-OES EPA Method 6010B
Anions: Br, Cl, F, NO ₃ , and SO ₄	Ion Chromatography, EPA Method 300.0
Dissolved carbon dioxide	Gas Chromatographic EPA Method RSK 175
Isotopes: $\delta^{13}\text{C}$ of DIC	Isotope ratio mass spectrometry
Total Dissolved Solids	Gravimetry: SM 2540C
Water Density (field)	Oscillating body method ASTM D1217
Alkalinity	Alkalinity by Titration SM:2320 B
pH (field)	Electrometric EPA-NERL: 150.1
Specific conductance (field)	4 AC electrode EPA-NERL: 120.1
Temperature (field)	Thermistor EPA-NERL: 170.1

Table 6: Post-injection phase pressure-front monitoring.

Target Formation	Monitoring Activity	Monitoring Location(s)	Spatial Coverage	Frequency
DIRECT PRESSURE-FRONT MONITORING				
Potosi	Pressure/ temperature monitoring	FM1 & FM2	1 point location @4,500 Ft MD (4,000 Ft TVDss)	Continuous

Schedule for Submitting Post-Injection Monitoring Results

All post-injection site care monitoring data and monitoring results (i.e., resulting from the groundwater monitoring and plume and pressure front tracking described above) will be submitted to the Director in annual reports. These reports will be submitted each year by January 31st.

Site Closure Plan

WCS will conduct site closure activities to meet the requirements of 40 C.F.R. § 146.93(e) as described below. WCS will submit a final Site Closure Plan and notify the Director at least 120 days prior of its intent to close the site per 40 C.F.R. § 146.93(d). Once the Director has approved closure of the site, WCS will plug the monitoring wells and submit a site closure report. The activities, as described below, represent the planned activities based on information provided to EPA. The actual site closure plan may employ different methods and procedures. A final Site Closure Plan will be submitted to the Director for approval with the notification of the intent to close the site.

Plugging Monitoring Wells

The well will be flushed with a kill weight brine fluid. A minimum of three tubing volumes will be injected without exceeding fracture pressure. A final external MIT will be conducted to ensure mechanical integrity. Detailed plugging procedures are provided below. All casing in this well will be cemented to surface and will not be retrievable at abandonment. After injection ceases and after the appropriate post-injection monitoring period is finished, the completion equipment will be removed from the well.

Type and Quantity of Plugging Materials, Depth Intervals

Well cementing software (e.g., Schlumberger's CemCade) will be used to model the plugging and aid in the plug design. The cements used for plugging will be tested in the lab prior to plug placement and both wet and dry samples will be collected during plugging for each plug to ensure quality of the plug.

All of the casing strings will be cut off at least 3 feet below the surface, below the plow line. A blanking plate with the required permit information will be welded to the top of the cutoff casing.

Volume Calculations

Volumes will be calculated for specific abandonment wellbore environments based on desired plug diameter and length required. Volume calculations are the same for plug and abandonment during construction and post-injection.

- 1) Choose the following:
 - a) Length of the cement plug desired.
 - b) Desired setting depth of base of plug.
 - c) Amount of spacer to be pumped ahead of the slurry.
- 2) Determine the following:
 - a) Number of sacks of cement required.
 - b) Volume of spacer to be pumped behind the slurry to balance the plug.
 - c) Plug length before the pipe is withdrawn.
 - d) Length of mud freefall in drill pipe.
 - e) Displacement volume required to spot the plug.
- 3) Field cementing and wellsite supervisor will both review calculations prior to spotting any plug.

Plugging and Abandonment Procedure

At the end of the serviceable life of the verification well, the well will be plugged and abandoned. In summary, the plugging procedure will consist of removing all components of the completion system and then placing cement plugs along the entire length of the well. Prior to placing the cement plugs, casing inspection and temperature logs will be run confirming external mechanical integrity. If a loss of integrity is discovered, then a plan to repair using the cement squeeze method will be prepared and submitted to the agency for review and approval. At the surface, the well head will be removed; and the casing will be cut off 3 feet below surface. A detailed procedure follows:

- 1) Notify the Director 48 hours prior to commencing operations. Ensure proper notifications have been given to all regulatory agencies for rig move.
- 2) Make sure all permits to P&A have been duly executed by all local, State & Federal agencies and Wabash have written permission to proceed with planned ultimate P&A procedure.

- 3) Ensure in advance that a pre-site inspection has been performed and the rig company has visited the site and is capable of transporting rig, tanks, and ancillary equipment to perform P&A operations. Notify all key third parties of expected work scope, and ensure third party contracts for work are in place prior to move in.
- 4) Have copies of all government permits prior to initiating operations and maintain on location at all times. Check to see if conditions of approval have been met.
- 5) Make sure partners (U.S. DOE, Indiana DEM (or Indiana DNR) and/or U.S. EPA, and Wabash) approvals have been obtained, as applicable.
- 6) Make sure all necessary safety forms are on the rig, i.e., NPDES, safety meetings, trip sheets, etc.

Plugging Procedures

- 1) Mobilize workover (WO) or Plugging Rig Equipment. Give appropriate notice before commencing operations.
- 2) Move in rig to well location. Notify the Project Coordinator before moving rig. Ensure all overhead restrictions (telephone, power lines, etc.) have been adequately previewed and managed prior to move in and rig up (MI & RU). All carbon dioxide pipelines will be marked and noted to Workover (WO) rig supervisor prior to moving in (MI) rig. Move rig onto location per operational procedures.
- 3) Conduct a safety meeting for the entire crew prior to operations, record date and time of all safety meetings, and maintain records on location for review.
- 4) Make daily "Project Inspection" walks around the rig. Immediately correct deficiencies and report deficiencies during the regulatory discussion during morning meetings/calls. Maintain International Association of Drilling Contractors (IADC) or plugging reports daily at the WO rig logbook or doghouse.
- 5) MI rig package and finish rigging up hoses, hydraulic lines, etc.
- 6) Open up all valves on the vertical run of the tree. Check pressures.
- 7) Rig up pump and line and test same to 2,500 psi. Fill casing with kill weight brine (9.5 lbs/gallon - ppg). Bleeding off occasionally may be necessary to remove all air from the system. Keep track and record volume of fluid to fill annulus (Hole should be full). If there is pressure remaining on tubing, rig to pump down tubing and inject two tubing volumes of kill weight brine. Monitor tubing and casing pressure for 1 hour. If both casing and tubing are dead, then nipple up blowout preventers (NU BOP's). Monitor casing and tubing pressures.
- 8) If needed, if well is not dead nor pressure cannot be bled off of tubing, rig up (RU) slickline (SL) and set X-lock plug in X nipple located in X-Plug in tailpipe below packer. Circulate well with kill weight brine. Ensure well is dead. Nipple down (ND) tree. NU Blowout Prevention Equipment (BOP's) and function test same. BOP's should have 4 ½" single pipe rams on top and blind rams in the bottom ram for 4 ½". Test BOP's as per local, state or federal provisions or utilize higher standard, 30 CFR250.616. Test pipe rams and blind rams to 250 psi low, 3,000 psi high. Test annular preventer to 250 psi low and 3,000 psi high. Test all Texas Iron Works (TIW's), BOP's, choke and kill lines, choke manifold, etc. to 250 psi low and 3,000 psi high. **NOTE: Make sure casing valve is open during all BOP tests.** After testing BOPs pick up 4 ½" tubing string and

unlatch seal assembly from seal bore. Rig slick line and lubricator back to well and remove X- plug from well. Rig to pump via lubricator and keep well dead.

- 9) RU 4 ½” rig hydraulic tubing tongs for handling of production tubing. Pick back up on tubing string and pull seal assembly from seal bore. Pull hanger to floor and remove same. Circulate bottoms up with packer fluid.
- 10) Pull out of hole (POOH) with tubing laying down same. **NOTE: Ensure well does not flow due to carbon dioxide “back flow”! Well condition is to be over-balanced at all times with at least 2 well control barriers in place at all times.**
- 11) Contingency: If unable to pull seal assembly, RU electric line and make cut on tubing string just above packer. Note: Cut must be made above packer at least 5-10 ft MD. Several different sizes of cutters and pipe recovery tools should be on location due to possible tight spots in tubing. If successful pulling seal assembly then pick up 3 ½ or 4 ½ inch workstring and Trip in Hole (TIH) with packer retrieving tools. If tubing was cut in previous step, then skip this step. Latch onto packer and pull out of hole laying down same. If unable to pull packer, pull work string out of hole and proceed to next step. Assuming tubing can be pulled with packer with no issues, run CBL cement bond log or USIT ultrasonic imager to determine that there is no leakage around the wellbore above the caprock. If leakage is noted, perform diagnostics to determine whether there is actual leakage or micro-annulus etc. Rerun CBL/USIT under pressure, if necessary, to eliminate micro-annulus effects. If leakage is confirmed, prepare cement remediation plan and execute during plugging operations. Set 7 5/8 inch cement retainer on wireline just in Oneota above the Potosi formation. Trip into hole with work string and sting into cement retainer. Test backside to 750 psi for 30 minutes on chart. A successful casing test should have less than 10% bleed off over the 30-minute period. This will be considered a successful casing test. Establish injection with packer kill fluid at 0.5, 1, and 2 BPM not to exceed 2,000 psi injection pressure. Sting out of retainer.
- 12) With pipe stung out of retainer, mix and pump EverCRETE carbon dioxide resistant cement mixed at 12.7 ppg plus fluid loss additive as proposed by cementing company and actual downhole conditions (temperature, bottom hole pressure (BHP), etc.). Obtain fluid loss of less than 100 cc/30 min. Follow that with EverCRETE carbon dioxide resistant cement mixed at 12.7 ppg with dispersant. Circulate to within 5 bbls of end of work/tubing string, sting into retainer and finish mixing cement. Displace tubing and squeeze away 30 bbls of cement into the open perforations. Note: Do not squeeze at higher pressures than 2,000 psi. Sting out of retainer and reverse out a minimum of 2 pipe volumes. Note: Leave cement on top of retainer.
- 13) Pull out of hole (POOH) racking back work string. Shut down for 12 hours. Trip in Hole (TIH) open ended. Tag up on cement on top of retainer and note same.
- 14) Circulate well and ensure well is in balance. Place tubing just above cement top from previous day. Mix and spot 500 ft balanced plug of EverCRETE carbon dioxide resistant cement in the 7 5/8-inch casing. Pull out of plug and reverse circulate tubing. Repeat this operation and spot a second 500 ft balance plug.
- 15) POOH racking back work string. Shut down for 12 hours. Trip in Hole (TIH) open ended. Tag up on cement on top of retainer and note same.
- 16) Circulate well and ensure well is in balance. Place tubing just above cement top from previous day. Mix and spot 500 ft balanced plug in the 7 5/8-inch casing. Pull out of plug and reverse circulate tubing. Repeat this operation until a total of 9 (including previously set EverCRETE plugs) plugs

have been set. If plugs are well balanced, then the reverse circulation step can be omitted until after each third plug. Lay down work string while pulling from well. If rig is working daylight only then pull 10 stands and rack back in derrick and reverse tubing before shutting down for night. The following morning, trip back in hole and tag plug and continue. After 9 plugs have been set pull tubing from well and shut in for 12 hours. Trip in hole with tubing and tag cement top. Calculate volume for final plug. Pull tubing back out of well. Nipple down BOPs and cut all casing strings below plow line (min 3 feet below ground level or per local policies/standards and Wabash requirements). Trip in well and set final cement plug. Lay down all work string, etc. Rig down all equipment and move out. Clean cellar to where a plate can be welded with well name onto lowest casing string at 3 ft or as per regulatory requirements. The steel plate/cap will have the well identification number, the UIC Class VI permit number, and the date of plug and abandonment inscribed on it. Soil will be backfilled around the well and the area planted with natural vegetation or as per regulatory requirements.

- 17) File all plugging forms to local state, federal and other agencies as required. After the completion of the plugging activities, a Plugging and Abandonment (P&A) Report as per EPA Form 7520-14 will be submitted to the EPA UIC Region 5 Office describing the details regarding the P&A job within 60 days of completing the plugging activities.

Approximately five days are required from move in to move out, depending on the operations at hand and the physical constraints of the well, weather, and other conditions.

Plugging the Confinement Monitor Well(s)

- 1) At the end of the serviceable life of the well, the well will be plugged and abandoned utilizing the following procedure:
- 2) Notify the permitting agency of abandonment at least 60 days prior to plugging the well.
- 3) Remove any monitoring equipment from well bore. Well will contain fresh water or a mixture of fresh water and native Silurian formation water.
- 4) Nipple down well head and connect cement pump truck to casing. Establish injection rate with fresh water. Mix and pump Class A cement (15.9 ppg). Slow injection rate to ½ bbl/min as cement starts to enter Silurian perforations. Continue squeezing cement into formation until a squeeze pressure of 500 psi is obtained. Monitor static cement level in casing for 12 hours and fill with cement if needed to top out. Plan to have 50 sacks additional cement above calculated volume on location to top out if needed. Cement volume requirements will be determined based upon actual well construction depths and final casing diameters used.
- 5) After cement cures, cut off all well head components and cut off all casings below the plow line.
- 6) Install permanent marker at surface, or as required by the permitting agency.
- 7) Reclaim surface to normal grade and reseed location.

Planned Remedial/Site Restoration Activities

- 1) To restore the site to its pre-injection condition following site closure, WCS will be guided by the state rules for plugging and abandonment of wells located on leased property.
- 2) The following steps or similar will be taken as required by state rules:

- 3) The free liquid fraction of the plugging fluid waste, which may consist of produced water and/or crude oil, shall be removed from the pit and disposed of in accordance with state and federal regulations (e.g., injection or in above ground tanks or containers pending disposal) prior to restoration. The remaining plugging fluid wastes shall be disposed of by on-site burial.
- 4) All plugging pits shall be filled and leveled in a manner that allows the site to be returned to original use with no subsidence or leakage of fluids, and where applicable, with sufficient compaction to support farm machinery.
- 5) All drilling and production equipment, machinery, and equipment debris shall be removed from the site.
- 6) Casing shall be cut off at least three (3) feet below the surface of the ground, and a steel plate welded on the casing.
- 7) Any drilling rat holes shall be filled with cement to no lower than four (4) feet and no higher than three (3) feet below ground level.
- 8) The well site and all excavations, holes, and pits shall be filled, and the surface leveled.

Site Closure Report

A site closure report will be prepared and submitted within 90 days following site closure per 40 C.F.R. § 146.93(f) and Section P(6) of this permit. The report will document the following:

- 1) Plugging of the verification and geophysical wells (and the injection well if it has not previously been plugged),
- 2) Location of sealed injection well on a plat of survey that has been submitted to the local zoning authority,
- 3) Notifications to state and local authorities as required at 40 C.F.R. § 146.93(f)(2),
- 4) Records regarding the nature, composition, and volume of the injected carbon dioxide, and
- 5) Post-injection monitoring records.
- 6) Any other information required by the Director.

WCS will record a notation to applicable property deeds per 40 C.F.R. § 146.93(g) documenting the following:

- 1) That the property was used for carbon dioxide sequestration,
- 2) The name of the local agency to which a plat of survey with injection well location was submitted,
- 3) The volume of fluid injected,
- 4) The formation into which the fluid was injected, and
- 5) The period over which the injection occurred.

The site closure report will be submitted to the Director and maintained by the owner or operator for a period of 10 years following site closure per 40 C.F.R. § 146.93(h). Additionally, the owner or operator will maintain the records collected during the post-injection period for a period of 10 years after which these records will be delivered to the Director.

ATTACHMENT F: EMERGENCY AND REMEDIAL RESPONSE PLAN

Facility Information

Facility name: Wabash Carbon Services
WVCCS1 and WVCCS2

Facility address: 444 W. Sandford Ave, West Terre Haute, IN 47885

Well location: WVCCS1 Clinton, Vermillion County, Indiana
39 37' 27.88" N, 87 29 19.17" W
(Decimal Degrees X, Y: -87.48866, 39.62441)
WVCCS2 West Terre Haute, Vigo County, Indiana
39 33' 3.72" N, 87 29' 16.60" W
(Decimal Degrees X,Y: -87.48794, 39.55103)

This attachment describes the Emergency and Remedial Response Plan (ERRP) per 40 C.F.R. § 146.94 and Section Q of this permit. For seismic events (natural or induced), actions must also include those described in Section M of this permit. This plan describes actions that Wabash Carbon Services (WCS) will take to address if WCS obtains evidence that the injected carbon dioxide stream and/or associated pressure front may cause an endangerment to an underground source of drinking water (USDW) during the construction, operation, or post-injection site care periods.

If WCS obtains evidence that the injected carbon dioxide stream and/or associated pressure front may cause an endangerment to a USDW, WCS must perform the following actions:

- 1) Initiate shutdown plan for the affected injection well.
- 2) Take all steps reasonably necessary to identify and characterize any USDW endangerment.
- 3) Notify the Director and EPA's National Response Center of the emergency event within 24 hours.
- 4) Implement applicable portions of the ERRP.

Where the phrase "initiate shutdown plan" is used, the following protocol will be employed: WCS will immediately cease injection. However, in some circumstances, WCS will, in consultation with the Director, determine whether gradual cessation of injection is more appropriate and if both wells need to be shut in.

Local Resources and Infrastructure

Resources in the vicinity of the Wabash CCS Project (WCCSP) Sequestration Well #1 (WVCCS1) & Sequestration Well #2 (WVCCS2) that may be affected as a result of an emergency event at the project site include: Underground Sources of Drinking Water (USDWs); potable water wells; and Brouilletts Creek.

Infrastructure in the vicinity of the WVCCS1 and WVCCS2 that may be affected as a result of an emergency at the project site include: Wellhead at WVCCS1 and WVCCS2; International Union of Operating Engineers Training Facility; and WCS facilities.

Figure 1: Area of Review

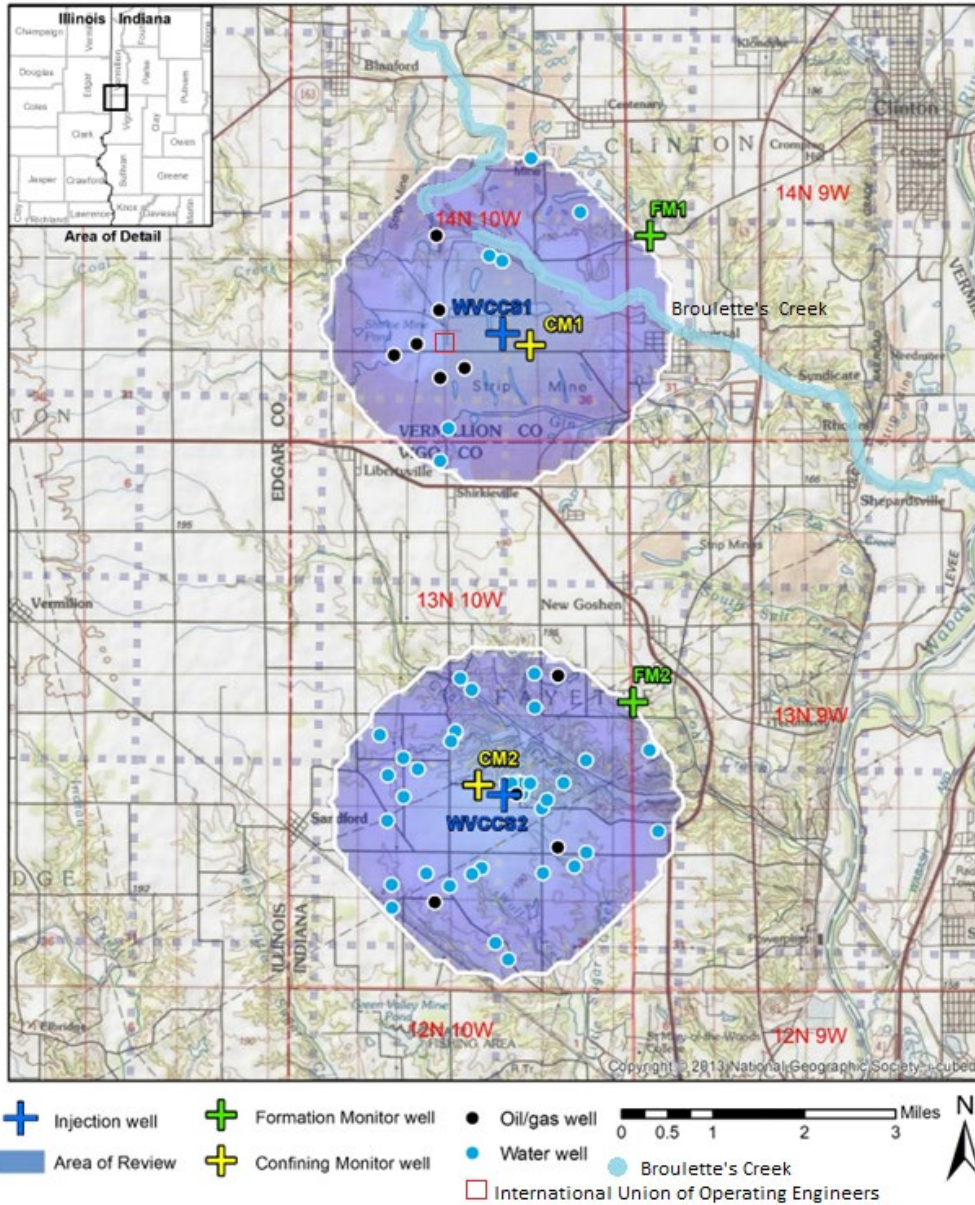

Potential Risk Scenarios

The following events related to the WCCSP that could potentially result in an emergency response:

- 1) Injection or monitoring (verification) well(s) integrity failure
- 2) Injection well monitoring equipment failure (e.g., shut-off valve or pressure gauge, etc.)
- 3) A natural disaster (e.g., earthquake, tornado, lightning strike)
- 4) Fluid (e.g., brine) leakage to a USDW
- 5) Carbon dioxide leakage to USDW or land surface

Response actions will depend on the severity of the event(s) triggering an emergency response. “Emergency events” are categorized as shown in Table 1.

Table 1: Degrees of risk for emergency events.

Emergency Condition	Definition
Major emergency	Event poses immediate substantial risk to human health, resources, or infrastructure. Emergency actions involving local authorities (evacuation or isolation of areas) should be initiated.
Serious emergency	Event poses potential serious (or significant) near term risk to human health, resources, or infrastructure if conditions worsen or no response actions taken.
Minor emergency	Event poses no immediate risk to human health, resources, or infrastructure.

Emergency Identification and Response Actions

Steps to identify and characterize the event will be dependent on the specific issue identified, and the severity of the event. The potential risk scenarios identified are detailed below.

Well Integrity Failure

A loss of well integrity either at the injection well and/or verification well may endanger USDWs. It should be noted that a pressure or temperature anomaly that may occur does not mean that in every instance this has led to a loss of well integrity. A potential well integrity loss or permit non-compliance may have occurred if the following events occur:

- 1) Automatic shutdown devices are activated:
 - a) Wellhead pressure exceeds the specified shutdown pressure specified in the permit.
 - b) Annulus pressure indicates a pressure communication anomaly or a potential loss of external or internal well containment.
- 2) Mechanical integrity test results identify a potential loss of mechanical integrity.

- 3) Monitoring wells detect injection fluid and/or pressures above the injection zone indicating possible upward fluid flow away from the injection well. (NOTE: Detection of injection fluid and/or pressure above the injection zone might also occur and not be related to a failure of external mechanical integrity of the injection well.)

Response actions:

- 4) Notify the Director and EPA National Response Center within 24 hours of the emergency event, per 40 C.F.R. § 146.91(c).
- 5) Determine the severity of the event, based on the information available, within 24 hours of notification.
- 6) For a Major or Serious emergency:
 - a) Initiate shutdown plan.
 - b) Shut in well (close flow valve).
 - c) Vent carbon dioxide from surface facilities located at Wabash Carbon Services (WCS) site.
 - d) Limit access to wellhead to authorized personnel only.
 - e) Communicate with WCS personnel, WVR personnel and local authorities to initiate evacuation plans, if necessary.
 - f) Monitor well pressure, temperature, and annulus pressure to verify integrity loss and perform diagnostics to determine the cause and extent of well integrity loss; identify and implement appropriate remedial actions to restore well integrity (in consultation with the Director).
 - g) If leakage out of the permitted injection zone or impacts on USDWs is detected, identify and implement appropriate remedial actions (in consultation with the Director)
- 7) For a Minor emergency:
 - a) Conduct assessment and/or diagnostics to determine whether there has been a minor pressure or temperature anomaly or permit non-compliance or actual loss of mechanical integrity.
 - b) If there has been a loss of mechanical integrity, initiate shutdown plan.
 - i) Shut in well (close flow valve).
 - ii) Vent carbon dioxide from surface facilities.
 - iii) Reset automatic shutdown devices.
 - iv) Monitor well pressure, temperature, and annulus pressure and perform diagnostics to verify integrity loss and determine the cause and extent of integrity loss; identify and, if necessary, implement appropriate remedial actions to restore well integrity (in consultation with the Director).
 - c) If there has been NO loss of integrity or permit non-compliance
 - i) Continue injection operation
 - ii) Determine cause of anomalous instrument reading

Injection Well Monitoring Equipment Failure

The failure of monitoring equipment for wellhead pressure, temperature, and/or annulus pressure may indicate a potential problem with the injection well that may endanger USDWs.

Response actions:

- 1) Notify the Director within 24 hours of the emergency event, per 40 C.F.R. § 146.91(c).
- 2) Determine the severity of the event, based on the information available, within 24 hours of notification.
- 3) Project management will make an initial assessment of the situation and determine which other project personnel to notify.
- 4) For a Major or Serious emergency:
 - a) Initiate shutdown plan.
 - b) Shut in well (close flow valve).
 - c) Vent carbon dioxide from surface facilities.
 - d) Limit access to wellhead to authorized personnel only.
 - e) Communicate with WCS personnel, WVR personnel and local authorities to initiate evacuation plans, as necessary.
 - f) Monitor well pressure, temperature, and annulus pressure (manually if necessary) to determine the cause and extent of failure.
 - g) Identify and, if necessary, implement appropriate remedial actions (in consultation with the UIC Program Director).
- 5) For a Minor emergency:
 - a) Conduct assessment to determine whether there has been a potential or actual loss of mechanical integrity.
 - b) If there has been an actual loss of mechanical integrity (and not a pressure and/or temperature monitoring anomaly or a permit non-compliance issue such as a plant upset), initiate shutdown plan.
 - c) Shut in well (close flow valve).
 - d) Vent carbon dioxide from surface facilities.
 - e) Reset or repair automatic shutdown devices.
 - f) Monitor well pressure, temperature, and annulus pressure (manually if necessary) to determine the cause and extent of potential or actual loss of integrity.
 - g) Identify and, if necessary, implement appropriate remedial actions to restore well and monitoring equipment integrity (in consultation with the Director).

Potential Contamination of USDW

The following response actions will occur to mitigate any potential contamination of USDW due to: acidification due to carbon dioxide migration; toxic metals dissolution; and degradation of USDWs with displaced formation fluids due to carbon dioxide injection.

The following triggering events could indicate the movement of fluid out of the injection zone and may result in the implementation of the response plan:

- 1) Result of any formational fluid testing (as defined in the QASP) that is above expected parameters
- 2) Monitoring Well down hole pressure measurement deviating from expected within any overlying layers
- 3) Monitoring Well down hole temperature measurement deviating from expected within any overlying layers
- 4) A sudden, significant decrease in injection pressure (assuming constant injection rate) that might indicate a breach of confinement

Response actions:

- 1) Immediately notify the WCS Project Manager or designee.
- 2) Notify the Director and EPA National Response Center within 24 hours of the emergency event, per 40 C.F.R. § 146.91(c).
- 3) The Project Manager will make an initial assessment of the situation and determine which other project personnel to notify.
- 4) Project contacts will determine the severity of the event, based on the information available, within 24 hours of notification.
- 5) For all emergencies (Major, Serious, or Minor):
 - a) Initiate shutdown plan.
 - b) Vent carbon dioxide from surface facilities.
 - i) Collect a confirmation sample(s) of groundwater and analyze for indicator parameters.
 - c) If the presence of indicator parameters is confirmed, develop (in consultation with the Director) a case-specific work plan to:
 - (a) Install additional groundwater monitoring points near the affected groundwater well(s) to delineate the extent of impact; and
 - (b) Remediate unacceptable impacts to the affected USDW.
 - d) Arrange for an alternate potable water supply, if the USDW was being utilized as a public or private water system has been caused to exceed drinking water standards.
 - e) Proceed with efforts to remediate the USDW to mitigate any unsafe conditions (e.g., install system to intercept/extract brine and/or contaminated water or “pump and treat” to aerate carbon dioxide -laden water).
 - f) Continue groundwater remediation and monitoring on a frequent basis (frequency to be determined by WCS and the Director) until unacceptable adverse USDW impact has been fully addressed.

Natural Disaster

If a natural disaster occurs that affects normal operation of the injection well, perform the following:

Response actions:

- 1) Immediately notify WCS Project Manager or Designee.
- 2) Notify the Director and EPA National Response Center within 24 hours of the emergency event, per 40 C.F.R. § 146.91(c). The Plant Manager or designee will make an initial assessment of the situation and determine which other project personnel to notify.
- 3) Project contacts will determine the severity of the event, based on the information available, within 24 hours of notification.
- 4) For a Major or Serious emergency:
 - a) Initiate shutdown plan.
 - b) Shut in well (close flow valve).
 - c) Vent carbon dioxide from surface facilities.
 - d) Limit access to wellhead to authorized personnel only.
 - e) Communicate with WCS personnel, WVR personnel and local authorities to initiate evacuation plans, as necessary.
 - f) Monitor well pressure, temperature, and annulus pressure (manually if necessary) to determine the cause and extent of failure.
 - g) Determine if any leaks to groundwater or surface water occurred.
 - h) If contamination or endangerment is detected, identify and implement appropriate remedial actions (in consultation with the Director).
- 5) For a Minor emergency:
 - a) Conduct assessment to determine whether there has been a loss of mechanical integrity.
 - b) If there has been NO loss of mechanical integrity reset automatic shutdown devices
 - c) If there has been a loss of mechanical integrity, initiate shutdown plan.
 - d) Shut in well (close flow valve).
 - e) Vent carbon dioxide from surface facilities.
 - f) Limit access to wellhead to authorized personnel only.
 - g) Monitor well pressure, temperature, and annulus pressure to verify integrity loss and determine the cause and extent of failure; identify and, if necessary, implement appropriate remedial actions (in consultation with the Director).

Response Personnel and Equipment

Site personnel, project personnel, and local authorities will be relied upon to implement this ERRP. The injection wells are located in Vermillion and Vigo Counties outside of any city limits. Therefore,

County emergency responders (as well as State agencies) will need to be notified in the event of an emergency.

Site personnel to be notified (not listed in order of notification):

- 1) Project Engineer(s)
- 2) Project Safety Manager(s)
- 3) Environmental Manager(s)
- 4) Project Manager
- 5) Project Operations Manager
- 6) Carbon Capture Plant Manager
- 7) Carbon Capture Plant Operations Supervisor

A site-specific emergency contact list will be developed and maintained during the life of the project. WCS will provide the current site-specific emergency contact list to the UIC Program Director.

Table 2: Contact information for key local, state, and other authorities.

Agency	Phone Number
Vigo County Sheriff	(812) 462-3226
Vermillion County Sheriff	(765) 492-3838
Indiana State Police	(317) 232-8248
New Goshen Volunteer Fire Department	(812) 535-3600
Indiana Department of Homeland Security	(317) 232-2222
Vigo County Emergency Management	(812) 462-3217
Vermillion County Emergency Management	(765) 832-5500
Environmental services contractor	TBD
UIC Program Director (US EPA Region V)	(312) 353-7648
EPA National Response Center (24 hours)	(800) 424-8802
Indiana State Water and Geological Survey	(812) 855-7636

Equipment needed in the event of an emergency and remedial response will vary, depending on the triggering emergency event. Response actions (cessation of injection, well shut-in, and evacuation) will generally not require specialized equipment to implement. Where specialized equipment (such as a drilling rig or logging equipment) is required, WCS shall be responsible for its procurement.

Emergency Communications Plan

WCS will communicate to the public about any event that requires an emergency response to ensure that the public understands what happened and whether there are any environmental or safety implications. The amount of information, timing, and communications method(s) will be appropriate to the event, its severity, whether any impacts to drinking water or other environmental resources occurred, any impacts to the surrounding community, and their awareness of the event.

WCS will describe what happened, any impacts to the environment or other local resources, how the event was investigated, what responses were taken, and the status of the response. For responses that occur over the long-term (e.g., ongoing cleanups), WCS will provide periodic updates on the progress of the response action(s).

WCS will also communicate with entities who may need to be informed about or take action in response to the event, including local water systems, carbon dioxide source(s) and pipeline operators, land owners, and Regional Response Teams (as part of the National Response Team).

Plan Review

This ERRP shall be reviewed:

- 1) At least once every five (5) years following permit issuance
- 2) Within one (1) year of an area of review (AOR) re-evaluation
- 3) Within a prescribe period (to be determined by the Director) following any significant changes to the injection process or the injection facility, or an emergency event; and/or
- 4) As required by the Director

If the review indicates that no amendments to the ERRP are necessary, WCS will provide the permitting agency with the documentation supporting the “no amendment necessary” determination.

If the review indicates that amendments to the ERRP are necessary, amendments shall be made and submitted to the Director within the reporting requirements per this permit.

Staff Training and Exercise Procedures

WCS will integrate the ERRP into the plant specific standard operating procedures and training program.

Implementation of Environmental, Health, and Safety Training

Periodic training will be provided, not less than annually, to well operators, project safety and environmental personnel, the project manager, Carbon Capture Plant operations supervisor, and corporate communications. The training plan will document that the above listed personnel have been trained and possess the required skills to perform their relevant emergency response activities described in the ERRP.

ATTACHMENT G: PRE-INJECTION TESTING PLAN**Facility Information**

Facility name: Wabash Carbon Services
WVCCS1

Facility address: 444 W. Sandford Ave, West Terre Haute, IN 47885

Well location: WVCCS1 Clinton, Vermillion County, Indiana
39 37' 27.88" N, 87 29 19.17" W
(Decimal Degrees X, Y: -87.48866, 39.62441)
WVCCS2 West Terre Haute, Vigo County, Indiana
39 33' 3.72" N, 87 29' 16.60" W
(Decimal Degrees X,Y: -87.48794, 39.55103)

As per 40 CFR § 146.87:

“During the drilling and construction of a Class VI injection well, the owner or operator must run appropriate logs, surveys and tests to determine or verify the depth, thickness, porosity, permeability, and lithology of, and the salinity of any formation fluids in all relevant geologic formations to ensure conformance with the injection well construction requirements under § 146.86 and to establish accurate baseline data against which future measurements may be compared.”

The following Pre-Operational Testing Plan describes how the requirements of 40 CFR 146.87 and 40 CFR 146.86 will be fulfilled.

Wabash Carbon Services (WCS) will be constructing a new well, WVCCS1, for the injection of CO₂ into the Potosi formation of the Illinois Basin at ~4,500 feet MD (3,950 TVDss). Prior to this construction WCS has completed the drilling and investigation of stratigraphic test well, Wabash#1 ~7.2 miles to the south east of the WCSS1 site. Wabash#1 included investigation of the geologic column to a depth of ~8,730 feet MD (8,180 TVDss). Data acquired during drilling and testing from Wabash#1 will be used for comparison purposes while interpreting the data that will be obtained during the drilling and completion of WVCCS1.

During the drilling of WVCCS1, a qualified Mud Logging company will capture samples at a frequency adequate to allow the identification of the formation tops. This information in combination with data collected during the drilling of the Wabash#1 stratigraphic test well will help determine the setting depths for the different casing sections.

The pre-operational testing will be performed in sequence with the well construction activities. As each portion of the well is constructed, a different suite of tests will be performed based on the bore hole conditions (open hole vs cased hole). This plan is broken into sections that will cover each major portion of the injection well and testing associated with each major section. Table 1 provides the primary

sections of the well along with estimated depths. The actual depths will be determined during the drilling operations based upon input from the mud log, geologist's inputs, and surrounding well data.

Table 1 Major Well Sections/Casing Details

Casing String	Casing Depth (MD feet)	Borehole Diameter (inches)	Casing Diameter (OD- inches)	Wall Thickness (inches)	Casing Material	String Weight
Conductor	0-100	Augured	30	1.094	H40	15,930
Surface	0-350	26	20	.438	J55	32,900
Intermediate	0~3,400	17 1/2	13 3/8	.430	N80	207,400
Long String (Carbon)	0~3,200	12 1/4	9 5/8	.545	N80	288,900
Long String (Chrome)	~3,200- ~5,400	12 1/4	9 5/8	.545	Chrome Alloy	

Conductor

The bore hole for the conductor will be drilled via auger to a depth of ~100 feet. Once the bore is established, the 30-inch conductor will be set and cemented to surface. Due to the shallow nature of the conductor section no pre-operational testing is proposed. Industry standards for cement setting time will be followed.

Surface Section

Surface casing will be set from 0 ft to 350 feet in a 26 inch bore hole to ensure coverage of potential coal and groundwater. The bore hole will be drilled using a conventional water-based mud (WBM) system. Due to the shallow nature of the surface casing no open hole testing is proposed. Table 2 shows all testing planned for the Surface Casing Section after the casing is installed and cemented.

Table 2 Surface Section Cased Hole Testing

Test Performed	Purpose/Comments
Cement Bond Log (CBL) or Ultrasonic Imaging Tool (USIT)	Cement Integrity
Leak Off Test (LOT)	Surface casing shoe and cement integrity
Pressure Test to ~2500-3000 PSI	Casing Integrity

Intermediate Section

The intermediate section will be set from 350 ft to ~3,400 ft in a 17 1/2 bore hole. The bore hole will be drilled using a conventional WBM system. During drilling operations mud logging of the cuttings return will be performed to provide information to the drilling crew concerning the formation tops and relevant depths. This information will also be used to correlate open hole logging results with other reference wells. A mud logging report will be developed and updated daily.

Directional surveys will be performed at a minimum of every 1000 ft. If site conditions and equipment availability allow more frequent surveys will be performed employing a down hole inclination device (FloDrift or equivalent) to maintain a vertical deviation of less than 5 degrees.

During drilling of the bore whole core samples will be gathered from the Maquoketa Shale at approximately 2600 feet MD (2050 TVDss) and the Shakopee section of the Knox Dolomite Group at approximately 3,354 feet MD (2,800 TVDss). These core samples will be used to verify the verify lithological properties of the formations overlaying the injection zone and the adequacy of the Maquoketa Shale as the primary seal.

Upon completion of the intermediate bore hole a full suite of open hole logs will be performed. Table 2 shows all testing planned for the open hole of the intermediate section.

Table 3 Intermediate Section Open Hole Testing

Log Performed	Purpose/Comments
Temperature Log	Formation Temperature Profile
1-Arm and 4-Arm Caliper	Bore Hole Diameter/Volume/Condition
Directional Survey	Bore Hole Verticality
Induction	<ul style="list-style-type: none"> Characterize basic geology (lithology, mineralogy, porosity, permeability)
Neutron	
Density	
Gamma Ray	
Microlog	
Spontaneous Potential	
Mud Resistivity	
Natural Gamma Ray Spectroscopy	

Elemental Spectroscopy	<ul style="list-style-type: none"> Enhanced characterization of geologic and geomechanical properties that control injectivity and confining zone/seal integrity
Formation Micro Imager (FMI)	
Magnetic Resonance	<ul style="list-style-type: none"> Dipole Sonic log will also provide data to calibrate surface seismic
Dipole Sonic	
Vertical Seismic Profile (VSP)	<ul style="list-style-type: none"> Provide formation depth data and allow refinement of existing 2D and future 3D seismic testing

After completion of the open hole logging the intermediate casing will be set and cemented. The intermediate casing will be set from 0 ft - ~3,400 ft. After completion of the cementing integrity tests will be performed to ensure the protection of USDWs is maintained. Table 4 includes the testing planned for the intermediate section after casing.

Table 4 Intermediate Section Cased Hole Testing

Test Performed	Purpose/Comments
Concrete Bond Log (CBL) or Ultrasonic Imaging Tool (USIT)	Cement Integrity
Leak Off Test (LOT)	Surface casing shoe and cement integrity
Pressure Test to ~2500-3000 PSI	Casing Integrity
Temperature Log	Determine natural geothermal gradient outside well for comparison to future temperature logs for external mechanical integrity evaluations

Long String Section

The long string section will be from ~3,400 ft – ~5,400 ft. The bottom of the long string section will be set ~150 feet into the Eau Claire formation. Setting the long string casing into the Eau Claire will provide a solid foundation for the well construction. This also allows for full logging of the Potosi formation after completion of the bore hole drilling activities. During drilling operations mud logging of the cuttings return will be performed to provide information to the drilling crew concerning the formation tops and relevant depths. This information will also be used to correlate open hole logging results with other reference wells. A mud logging report will be developed and updated daily.

Directional surveys will be performed at a minimum of every 1000 ft. If site conditions and equipment availability allow more frequent surveys will be performed employing a down hole inclination device (FloDrift or equivalent) to maintain a vertical deviation of less than 5 degrees.

During drilling operations whole core samples of the Potosi formation will be collected. The target depths for the core sample will be based upon information collected from the Wabash#1 stratigraphic

test well. Core intervals will overlap the highly vugular zones that are the targets for injection between ~ 4,500 - ~4,700 ft.

Upon completion of the long section bore hole a full suite of open hole logs will be performed. Table 5 shows all testing planned for the open hole of the intermediate section

Table 5 Long String Open Hole Testing

Log Performed	Purpose/Comments
Temperature Log	Formation Temperature Profile
1-Arm and 4-Arm Caliper	Bore Hole Diameter/Volume/Condition
Directional Survey	Bore Hole Verticality
Induction	<ul style="list-style-type: none"> Characterize basic geology (lithology, mineralogy, porosity, permeability)
Neutron	
Density	
Gamma Ray	
Microlog	
Spontaneous Potential	
Mud Resistivity	
Natural Gamma Ray Spectroscopy	<ul style="list-style-type: none"> Enhanced characterization of geologic and geomechanical properties that control injectivity and confining zone/seal integrity Dipole Sonic log will also provide data to calibrate surface seismic
Elemental Spectroscopy	
Formation Micro Imager (FMI)	
Magnetic Resonance	
Dipole Sonic	
Quantitative ELAN	
Vertical Seismic Profile (VSP)	<ul style="list-style-type: none"> Provide formation depth data and allow refinement of existing 2D and future 3D seismic testing

The hydraulic fracture gradient will be measured in open hole right after drilling, and before casing is run. The test is called a "mini-frac" and will be performed with the Modular Dynamic Testing (MDT) tool.

The configuration is to go in with the tool consisting of a pair of inflatable packers, ~3 feet apart. At the interval to be tested, the packers are inflated by pumping wellbore fluid into the packers, sealing them against the formation. At this point, wellbore fluid is then pumped between the packers against the formation. Real-time monitoring of the pressure is done at surface. The pressure is slowly raised until the rock breaks, providing a direct measurement of the fracture pressure of the formation. The pressure is then allowed to bleed off to show the closure pressure. The cycle is repeated at this point several times to measure the fracture extension pressure and repeated closure pressure measurements. After this, the packers are deflated, and the tool can be moved to a new spot in the sealing formation for a repeat of the measurements. A limitation would be that the pump cannot build up pressure faster than the reservoir will take the fluid. This will be determined at the time the logs are run.

After completion of the open hole logging the long string casing will be set and cemented. The long string casing will be set from 0 ft - ~5,400 ft. After completion of the cementing integrity tests will be performed to ensure the protection of USDWs is maintained. Table 6 includes the testing planned for the intermediate section after casing.

Table 6 Long String Cased Hole Testing

Test Performed	Purpose/Comments
Concrete Bond Log (CBL) or Ultrasonic Imaging Tool (USIT)	Cement Integrity
Leak Off Test (LOT)	Surface casing shoe and cement integrity
Pressure Test to ~2500-3000 PSI	Casing Integrity
Temperature Log	Determine natural geothermal gradient outside well for comparison to future temperature logs for external mechanical integrity evaluations
Baseline casing inspection	Obtain baseline assessment of casing condition through confining zone for comparison to future casing inspection logs

After all casing is set the lowermost interval will be perforated to allow for injection into the desired section of the Potosi formation. After the casing is perforated a series of injectivity tests and formation fluid tests will be performed. Table 7 includes the testing planned before the commencement of operation of the injection well.

Table 7 Formation Testing

Test Performed	Purpose/Comments
Fluid Temperature	Determine natural geothermal gradient outside well for comparison to future temperature logs for external mechanical integrity evaluations
Fluid pH	Provide baseline of formation pH for reference to future samples
Fluid Conductivity	Provide baseline of formation Conductivity for reference to future samples
Reservoir Native Pressure	Provide baseline of formation pressure for comparison during injection activities and CO2 plume monitoring
Static Fluid Level	Determination of bottomhole pressure
Pressure Fall Off Test	Verification of connectivity of sequestration field
Step Rate Test	Determination of Fracture Pressure, Frac Gradient and highest allowable injection pressure
Injectivity Test	Verification of the injectivity rates used in the Plume and AOR simulations

Data Analysis and Reporting

WCS will submit to the Director a detailed report prepared by a log analyst that includes: Well log analyses (including well logs), core analyses, and formation fluid sample information.

ATTACHMENT H: WELL CONSTRUCTION DETAILS

Facility Information

Facility name: Wabash Carbon Services
WVCCS1 and WVCCS2

Facility address: 444 W. Sandford Ave, West Terre Haute, IN 47885

Well location: WVCCS1 Clinton, Vermillion County, Indiana
39 37' 27.88" N, 87 29 19.17" W
(Decimal Degrees X, Y: -87.48866, 39.62441)
WVCCS2 West Terre Haute, Vigo County, Indiana
39 33' 3.72" N, 87 29' 16.60" W
(Decimal Degrees X,Y: -87.48794, 39.55103)

Figure 1: Injection Well Construction Diagram

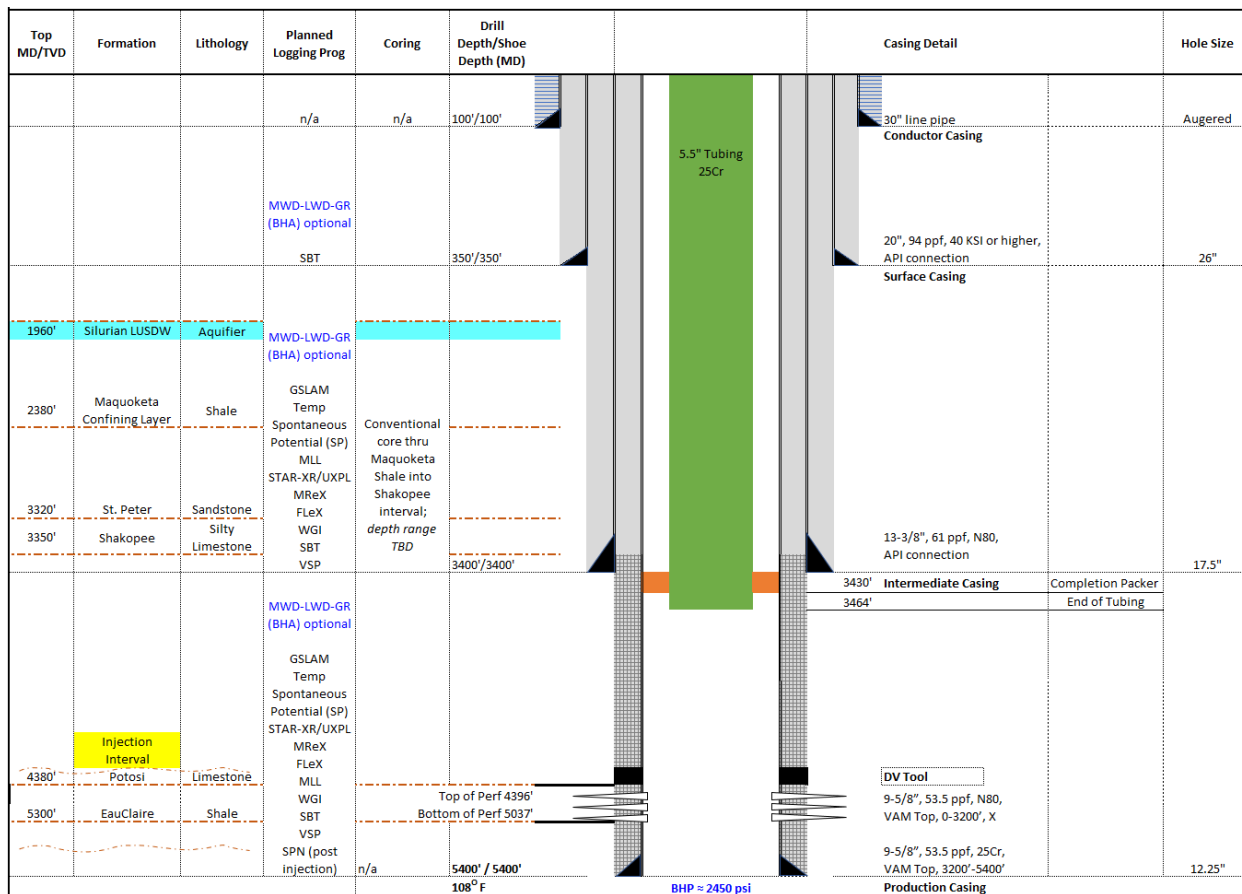
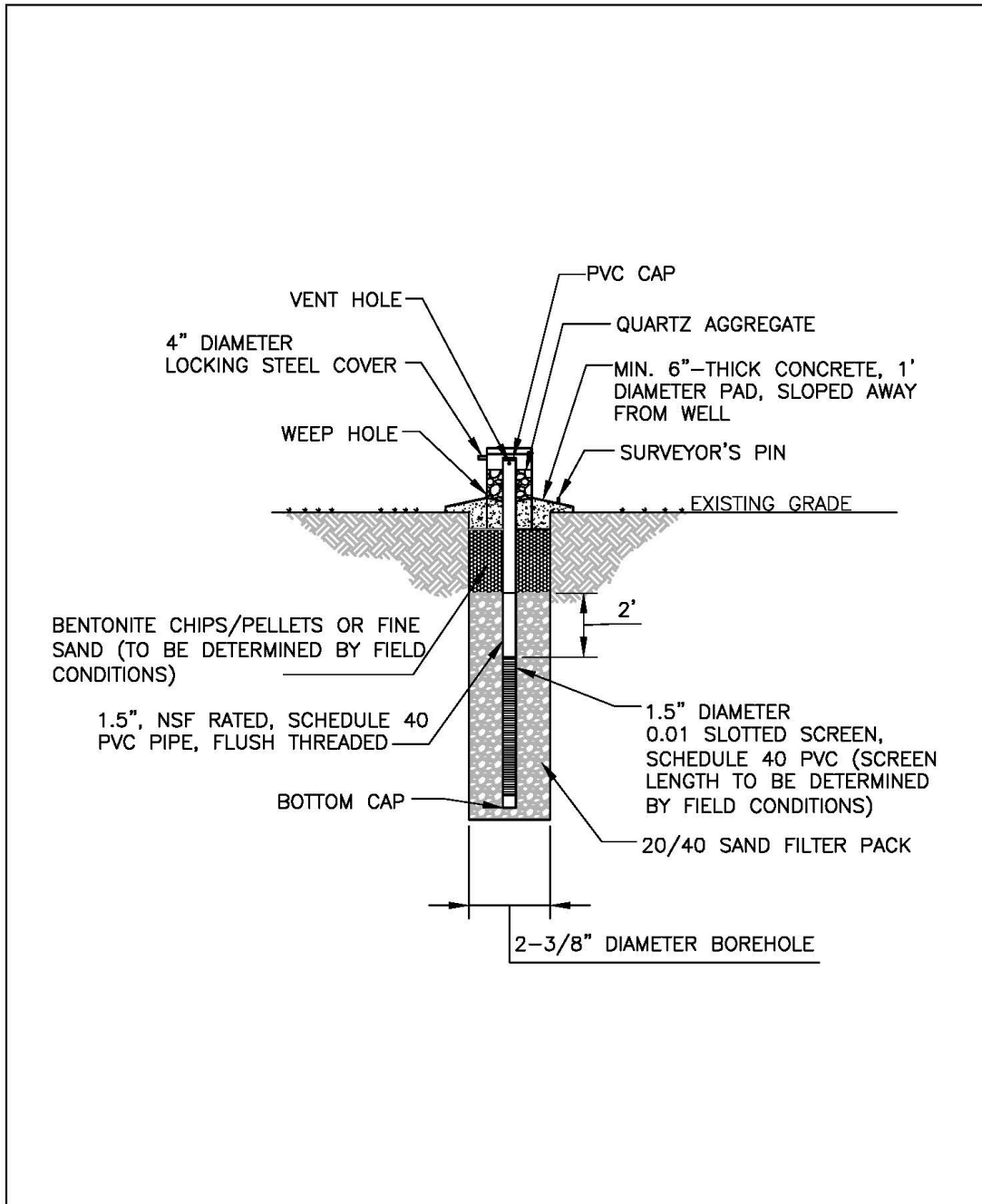

Figure 2: Groundwater Monitoring Well Construction Diagram (typical)



	GENERAL GROUNDWATER MONITORING WELL CONSTRUCTION DIAGRAM	DATE 4/24/13
		FIGURE 1

Figure 3: Confining Zone Monitoring Well Construction Diagram



Note: Drawing not to scale; hardcopies are uncontrolled.

Figure 4: Injection Zone Monitoring Well Construction Diagram

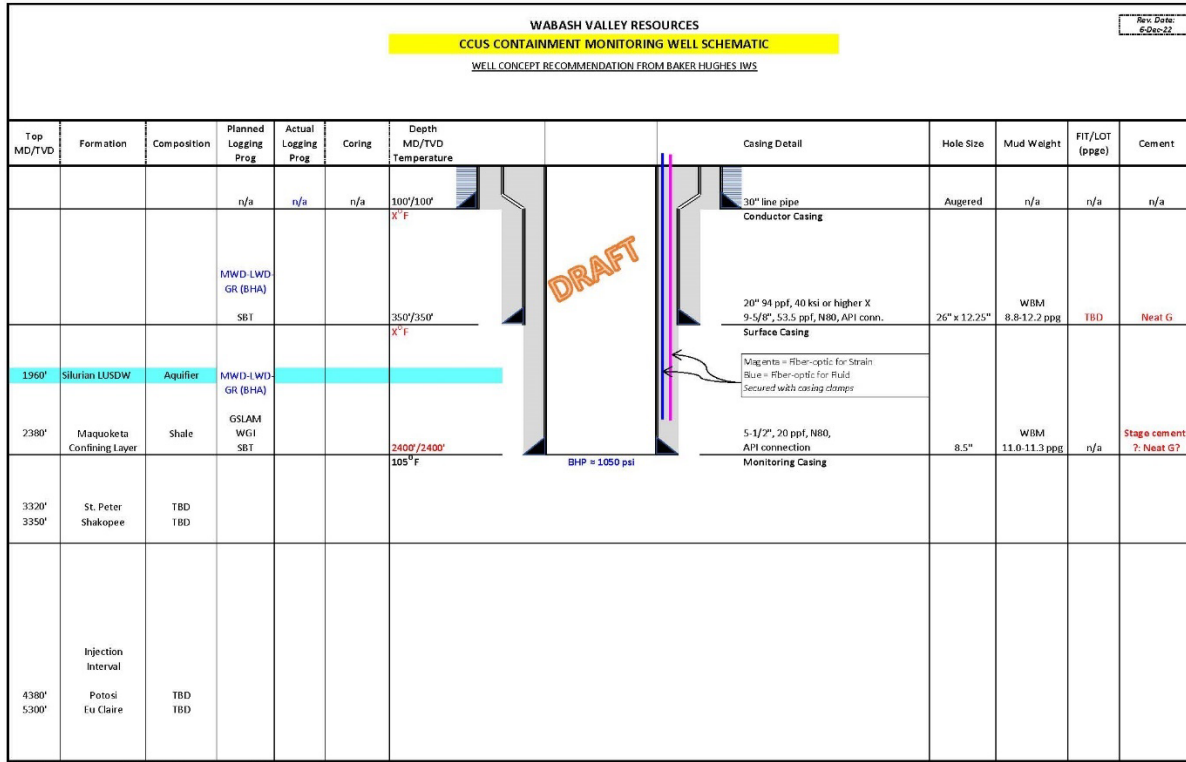
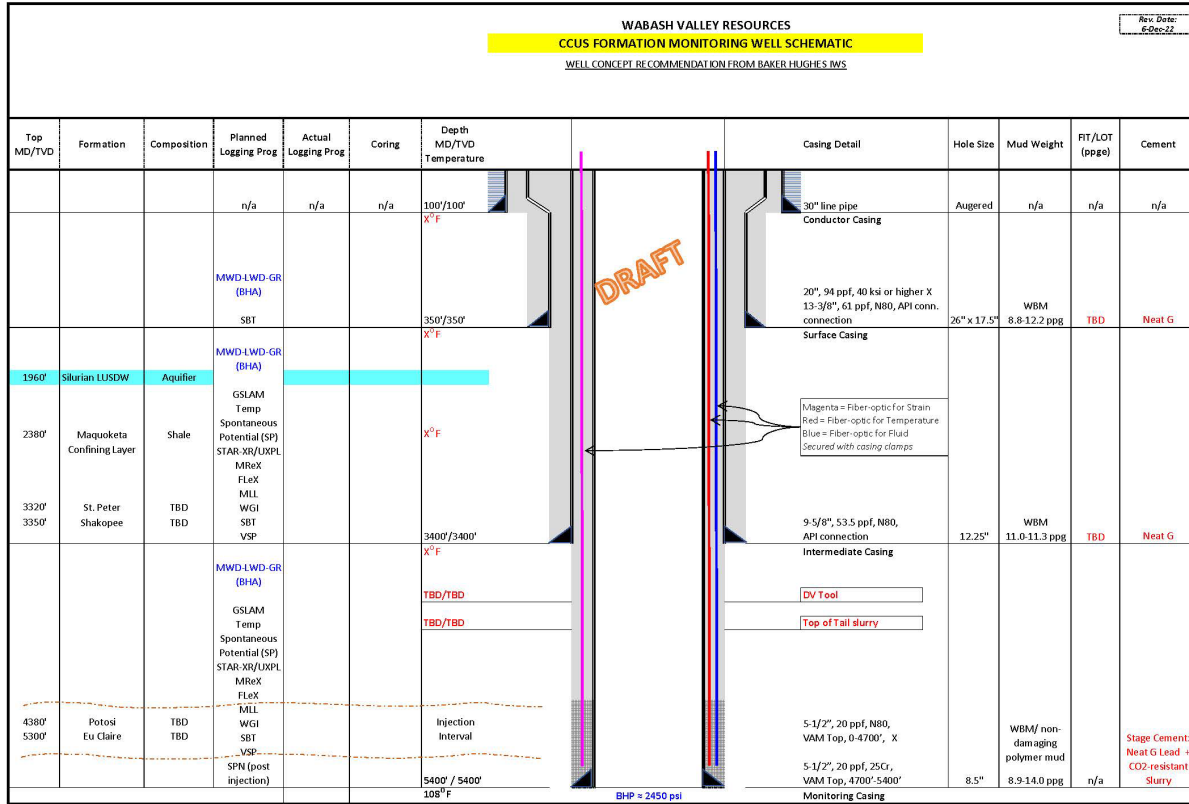

Note: Drawing not to scale; hardcopies are uncontrolled.

**ATTACHMENT I: FINANCIAL RESPONSIBILITY COST
ESTIMATE AND DOCUMENTS**

Facility Information

Facility name: Wabash Carbon Services
WVCCS1 and WVCCS2

Facility address: 444 W. Sandford Ave, West Terre Haute, IN 47885

Well location: WVCCS1 Clinton, Vermillion County, Indiana
39 37' 27.88" N, 87 29 19.17" W
(Decimal Degrees X, Y: -87.48866, 39.62441)
WVCCS2 West Terre Haute, Vigo County, Indiana
39 33' 3.72" N, 87 29' 16.60" W
(Decimal Degrees X,Y: -87.48794, 39.55103)

Wabash Carbon Services, LLC has demonstrated adequate financial responsibility to cover all costs associated with the requirements of this permit, as determined by third-party estimates, using financial instruments as listed in 40 C.F.R. § 146.85(a)(1). The standby trust agreement and financial instruments are part of the Administrative Record for this permit.

TRUST FUND MONETIZATION SCHEDULE

The CO2 Trust Fund will be funded according to when the financial risks are incurred on the Wabash Carbon Sequestration Project in four distinct activities:

- Pre-Injection: Once an injection or monitoring well is drilled, plugging cost will eventually need to be incurred. Therefore, the trust account will be funded with the cost of plugging injection and monitoring wells prior to drilling the wells. Wabash Carbon Services estimates cost of this activity at \$1,935,602.
- Injection: As soon as injection of CO2 begins in the Class VI well(s), certain activities will necessarily need to occur (post-injection site care and monitoring and site closure). Therefore, the trust account should be funded with the costs associated with these activities. Wabash Carbon Services estimates the cost of these activities at \$2,590,928.
- Post-Injection: All costs must be covered at the start of the post-injection phase. The trust account may phase out these costs as the activities are completed (with approval from the Director). For example, once wells have been plugged, their corresponding plugging costs may be subtracted from the total value of the trust account.
- Emergency and Remedial Response: Prior to authorization from the EPA to begin injecting CO2 under the Class VI permit, Wabash Carbon Services must be prepared to undertake any emergency or remedial response actions, although such actions are unlikely to be needed. Wabash Carbon Services estimates the cost of Emergency and Remedial Response to be at \$9,378,796.

Within seven (7) calendar days after the issuance of final Class VI UIC permits for the Wabash

Carbon Services wells, Wabash Carbon Services will ensure that \$1,935,602 is in the CO2 Trust Fund to cover the cost of plugging injection and monitoring wells in the Pre-Injection Period. In addition, Wabash Carbon Services will ensure that \$9,378,796 is in the CO2 Trust Fund to cover the cost of Emergency and Remedial response during the construction period and prior to the start of the CO2 injection.

On or before the one-year anniversary of the issuance of the final Class VI UIC permit for the Wabash Carbon Service injection wells, and at least seven (7) calendar days prior to EPA authorization for the start of the CO2 injection in either of the wells (whichever is earlier), Wabash Carbon Services will ensure that an additional \$2,590,928 is in the CO2 trust fund to cover the costs of the Post-Injection Site Care tasks. The total value of the trust at the beginning of the Injection Period will be \$13,905,326.

TOTAL FINANCIAL RESPONSIBILITY COST ESTIMATES

Financial Responsibility Element	Cost Estimate	When Funded
Injection Well Plugging	\$883,874	Prior to well construction
PISC and Site Closure		
Monitor Well Plugging	\$1,081,728	Prior to well construction
Site Remediation	\$777,000	
PISC Testing & Monitoring	\$7,525,920	
Total Cost	\$9,384,648	
Emergency and Remedial Response	\$9,378,796	Before authorization to inject can be granted
Total Cost	\$19,647,318	
Escalation 2021 to 2023	\$24,595,553	
Well O&M during injection Period	\$8,037,536	After 1 year of injection
Well O&M during PISC	\$2,588,640	
Total Financial Responsibility	\$35,221,729	

BREAKDOWN OF COST ELEMENTS

Well Site Remediation	
Item	Cost per Pad
Removal of pad material, replacement with topsoil and final grading	\$129,500

Injection Well Plugging		
Plug #	Item	Cost per well
1-3	Schlumberger CO ₂ Resistant Concrete (includes pumping) (2 Days)	\$351,010
4-9	Class H Cement Plug (includes pumping) (1 day)	\$32,427
	Workover rig mob	\$10,000
	Rig time 7 days/3,500 per day	\$24,500
	BOP	\$2,000
	Work String	\$7,000
	Power Tongs	\$5,000
	De Mob rig	\$10,000
	Total Cost	\$441,937
	Total Cost (2 injection)	\$883,874

Confinement Monitoring Well Plugging	
Item	Cost
Class H Cement Plug (includes pumping) (1 day)	\$32,427
Workover rig mob	\$10,000
Rig time 5 days/3,500 per day	\$17,500
BOP	\$2,000
Work String	\$7,000
Power Tongs	\$5,000
De Mob rig	\$10,000
Total Cost	\$83,927
Total Cost (2 Wells)	\$167,854

Formation Monitoring Well Plugging		
Plug #	Item	Cost per well
1-3	Schlumberger CO ₂ Resistant Concrete (includes pumping) (2 Days)	\$351,010
4-9	Class H Cement Plug (includes pumping) (1 day)	\$32,427
	Workover rig mob	\$10,000
	Rig time 7 days/3,500 per day	\$24,500
	BOP	\$2,000
	Work String	\$7,000
	Power Tongs	\$5,000
	De Mob rig	\$10,000
	Total Cost	\$441,937
	Total Cost (2 Wells)	\$883,874

USDW Remediation Cost Estimate		
Item	Cost	Note
Planning and Permitting	\$798,000	
Leak Investigation / Hydrogeological Study	\$1,994,200	10 wells install and Sample
Well Installation & Modifications	\$1,126,025	4 extraction wells install, injection well convert
Extraction Pumps - 10 GPM/well, 2400 Ft, 40 GPM total	\$819,700	4 Ext. pumps install and electric service
Injection Water Source	\$307,200	4 water wells w/ pumps; inj. Pump and electric service
Extraction Fluid Treatment (40 GPM, Adsorption - 2 yrs)	\$245,970	Treatment system & media change outs
Site Improvement - Office / Treatment Buildings	\$774,850	Elec Svc, treatment trailer, office trailer, fencing
Excavation Work - Remediation System Install	\$131,560	Trenching to wells for water and elec. Piping
Operations, Maintenance, Monitoring of Remed. System	\$1,353,158	2.25 Yrs O&M
System Decommissioning - Site Restoration	\$265,000	Removal
Total	\$7,815,663	
20% Contingency	\$9,378,796	

Groundwater Monitoring Well Plugging	
Item	Cost
Crew Mobilization	\$1,500
Cement and Materials	\$1,000
Site cleanup	\$500
Total Cost	\$3,000
Total Cost (10 Wells)	\$30,000

O & M - Injection Well	
Item	Annualized Cost
Wellhead Greasing (1/yr)	\$4,000
Pressure MIT (1/yr)	\$2,000
Temperature/Noise MIT (1/5yr)	\$2,000
Painting (1/yr)	\$1,500
Lease Road/Pad Maintenance (1/yr)	\$1,000
Gauge Calibration / Testing (1/yr)	\$1,500
Site Electric/Data	\$1,200
Site Data Shack	\$1,200
Spinner, PFO (1/3yr)	\$13,333
PN Log	\$50,000
On Call General support (1/month)	\$18,000
CO ₂ Alarm Checks/Cali (1/yr)	\$1,500
DTS MIT Interpretation (1/yr)	\$1,500
Downhole Gauge Calibration (1/yr)	\$20,000
Valves (8) Rebuild (1/10 yr)	\$5,000
Total Annual Cost (2 wells)	\$247,467

O & M - Shallow Monitor Well	
Item	Annualized Cost
Pressure MIT (1/5yr)	\$1,200
Temperature/Noise MIT (1/5yr)	\$2,000
Painting (1/yr)	\$1,500
Lease Road/Pad Maintenance (1/yr)	\$1,000
Gauge Calibration / Testing (1/yr)	\$1,500
Site Electric/Data	\$1,200
Site Data Shack	\$1,200
Fluid Sampling (1/yr)	\$56,732
Total Annual Cost (2 wells)	\$132,664

O & M - Deep Monitor Well	
Item	Annualized Cost
Wellhead Greasing (1/yr)	\$4,000
Pressure MIT (1/5yr)	\$1,200
Temperature/Noise MIT (1/5yr)	\$2,000
Painting (1/yr)	\$1,500
Lease Road/Pad Maintenance (1/yr)	\$1,000
Gauge Calibration / Testing (1/yr)	\$1,500
Site Electric/Data	\$1,200
Site Data Shack	\$1,200
PN Log	\$50,000
On Call General support (1/month)	\$18,000
CO ₂ Alarm Checks/Cali (1/yr)	\$1,500
Fluid Sampling (1/yr)	\$56,732
Valves (8) Rebuild (1/10 yr)	\$5,000
Total Annual Cost (2 Wells)	\$289,664

PISC COST BREAKOUT

PISC Time Period Years	10				
Testing and Monitoring Cost					
	Groundwater Sampling	Groundwater Report Generation	Deep Well Sampling Oversight & Report	Deep Well Sample Collection	Wire Line Logs
Professional Fees	\$2,725	\$3,730	\$11,120	\$40,000	\$50,000
KEI Equipment & Expenses	\$2,171	\$75	\$2,438		
Laboratory Fees	\$4,642		\$3,174		
Waste Disposal	\$173				
Workover Rig Mobilization					\$80,000
Cost Per Event	\$9,711	\$3,805	\$16,732	\$40,000	\$130,000

Annual Testing & Monitoring Cost		Number Events/Yr	Cost/Year
Groundwater Sample 1 Event	\$13,516	4	\$54,064
Deep Well Sample 1 Event	\$56,732	4	\$226,928
Wire Ling Logs	\$130,000	2	\$260,000
Total Cost/Yr			\$540,992
Cost for PISC period			\$5,409,920
Periodic Testing		Number Events/PISC	Cost
Seismic Evaluation 16 sq mile area			\$1,058,000
Plume Area Seismic Cost		1	\$2,116,000
Total PISC T&M Costs			\$7,525,920

ATTACHMENT J: STIMULATION PROGRAM**Facility Information**

Facility name: Wabash Carbon Services
WVCCS1 and WVCCS2

Facility address: 444 W. Sandford Ave, West Terre Haute, IN 47885

Well location: WVCCS1 Clinton, Vermillion County, Indiana
39 37' 27.88" N, 87 29 19.17" W
(Decimal Degrees X, Y: -87.48866, 39.62441)
WVCCS2 West Terre Haute, Vigo County, Indiana
39 33' 3.72" N, 87 29' 16.60" W
(Decimal Degrees X,Y: -87.48794, 39.55103)

Stimulation to enhance the injectivity potential of the injection zone may be necessary. Stimulation may involve but is not limited to flowing fluids into or out of the well, increasing or connecting pore spaces in the injection formation, or other activities that are intended to allow the injectate to move more readily into the injection formation. Advance notice of all proposed stimulation activities must be provided to the Director, as detailed below, prior to conducting the stimulation. The permittee must describe any fluids to be utilized for stimulation activities and the permittee must demonstrate that the stimulation will not interfere with containment. The permittee must submit proposed procedures for all stimulation activities to the Director in writing at least 30 days in advance, per 40 C.F.R. § 146.91(d)(2). Within the 30-day notice period, EPA may: deny the stimulation; approve the stimulation as proposed; or approve the stimulation with conditions. The permittee must carry out the stimulation procedures, including any conditions, as approved or set forth by EPA.